



Panasonic Omnivision **VHS**

Combination VCR Operating Instructions

Models **PV-M2759/PV-M2789**



Easy Taping.

Please read these instructions carefully before attempting to connect, operate or adjust this product.
Please save this manual.

Spanish Quick Use Guide is included. (Guía para rápida consulta en español está incluida.)

For assistance, call 1-800-211-PANA(7262)

Basic Operation

Advanced Operation

For Your Information

Important Safeguards and Precautions

READ AND RETAIN ALL SAFETY AND OPERATING INSTRUCTIONS. HEED ALL WARNINGS IN MANUAL AND ON UNIT

INSTALLATION

1 POWER SOURCE CAUTION

Operate only from power source indicated on unit or in this manual. If uncertain, have an Electric Utility Service Company or Video Products Dealer verify your home power source.

2 POWER CORD PLUG

For safety, this unit comes with a polarized type plug (one wide blade), or a three-wire grounding type plug.

POLARIZED PLUG CAUTION:

The plug fits into outlet one way. If it cannot be fully inserted, try reversing it. If it still will not fit, have an electrician install the proper wall outlet. Do not tamper with the plug.

GROUNDING PLUG CAUTION:

The plug requires a three-hole grounding outlet. If necessary, have an electrician install the proper outlet. Do not tamper with the plug.

3 POWER CORD

Make sure power cords are routed so they are not likely to have anything rest on them, roll over them, or be in the way of walking traffic. An extension cord should have the same type plug (polarized or grounding) and must be securely connected. Overloading wall outlets or extension cords may cause fire hazard. Frayed cords, damaged plugs, and damaged or cracked wire insulation are hazardous and should be replaced by a qualified electrician.

4 DO NOT BLOCK VENTILATION HOLES

Ventilation openings in the cabinet release heat generated during operation. If blocked, heat build-up may result in a fire hazard or heat damage to cassettes.

For your protection:

- Never cover ventilation slots while unit is ON, or operate unit while placed on a bed, sofa, rug, or other soft surface.
- Avoid built-in installation, such as a book case or rack, unless properly ventilated.

5 AVOID EXTREMELY HOT LOCATIONS OR SUDDEN TEMPERATURE CHANGES

Do not place unit over or near a heater or regulator, in direct sunlight, etc. If unit is suddenly moved from a cold place to a warm place, moisture may condense in unit and on the tape causing damage.

6 TO AVOID PERSONAL INJURY

- Never place unit on support or stand that is not firm, level, and adequately strong. The unit could fall causing serious injury to a child or adult and damage to the unit.
- Move any appliance and cart combination with care.
- Quick stops, excessive force, and uneven surfaces may cause objects to overturn.
- Carefully follow all operating instructions.



OUTDOOR ANTENNA INSTALLATION

1 SAFE ANTENNA AND CABLE CONNECTION

An outside antenna or cable system must be properly grounded to provide some protection against built up static charges and voltage.

Section 810 of the National Electrical Code, ANSI/NFPA 70 (in Canada, part 1 of the Canadian Electrical Code) provides information regarding proper grounding of the mast and supporting structure, grounding of the lead-in wire to an antenna discharge unit, size of grounding conductors, location of antenna discharge unit, connection to grounding electrodes, and requirements for the grounding electrode.

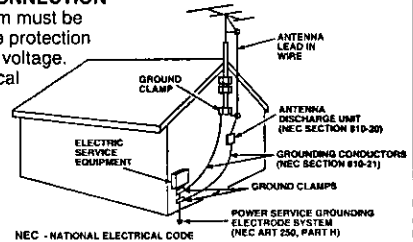

2 KEEP ANTENNA CLEAR OF HIGH VOLTAGE POWER LINES OR CIRCUITS

Locate an outside antenna system well away from power lines and electric light or power circuits so it will never touch these power sources should it ever fall. When installing antenna, absolutely never touch power lines, circuits or other power sources as this could be fatal.

USING THE VIDEO UNIT

Before unit is brought out of storage or moved to a new location, refer again to the INSTALLATION section of these safeguards.

1 KEEP UNIT WELL AWAY FROM WATER OR MOISTURE, such as a kitchen sink, bath tub, pool, and so on.

2 IF EXPOSED TO RAIN, MOISTURE, OR STRONG IMPACT, unplug unit and have it inspected by a qualified service technician before use.

3 ELECTRICAL STORMS

During a lightning storm, or before leaving unit unused for extended periods of time, disconnect all equipment from the power source as well as the antenna and cable system.

4 WHEN UNIT IS PLUGGED IN

- Never expose to rain or water. DO NOT OPERATE if liquid has been spilled into unit. Immediately unplug unit, and have it inspected by a service technician. Fire and shock hazards can result from electrical shorts caused by liquid contact inside.
- Never drop or push any object through openings in unit. Some internal parts carry hazardous voltages and contact can cause electric shock or fire hazard.
- Avoid placing unit directly on top or underneath a TV as this may cause electrical interference. Keep all magnets away from electronic equipment.

5 USING ACCESSORIES

Use only accessories recommended by the manufacturer to avoid risk of fire, shock, or other hazards.

6 CLEANING UNIT

Unplug unit. Use a clean, dry, chemically untreated cloth to gently remove dust or debris. DO NOT USE cleaning fluids, aerosols, or forced air that could over-spray, or seep into unit and cause electrical shock. Any substance, such as wax, adhesive tape, etc. may mar the cabinet surface. Exposure to greasy, humid, or dusty areas may adversely affect internal parts.

SERVICE

1 DO NOT SERVICE PRODUCT YOURSELF

If, after carefully following detailed operating instructions, the unit does not operate properly, do not attempt to open or remove covers, or make any adjustments not described in the manual. Unplug unit and contact a qualified service technician.

2 REPLACEMENT OF PARTS

Make sure the service technician uses only parts specified by the manufacturer, or have equal safety characteristics as original parts. The use of unauthorized substitutes may result in fire, electric shock, or other hazards.

3 SAFETY CHECK AFTER SERVICING

After unit is serviced or repaired, request that a thorough safety check be done as described in the manufacturer's service literature to insure video unit is in safe operating condition.

Safety Precautions

Warning: To prevent fire or shock hazard, do not expose this equipment to rain or moisture.

This video recorder, equipped with the HQ (High Quality) System, is compatible with existing VHS equipment.

Only use those tapes with the **VHS** mark. It is recommended that only cassette tapes that have been tested and inspected for use in 2, 4, 6, and 8 hour VCR machines be used.

This television receiver provides display of television closed captioning in accordance with §15.119 of the FCC rules.

FCC WARNING: Any unauthorized changes or modifications to this equipment would void the user's authority to operate.

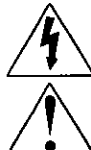
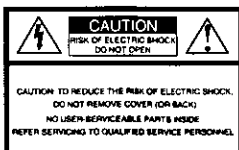

This symbol warns the user that uninsulated voltage within the unit may have sufficient magnitude to cause electric shock. Therefore, it is dangerous to make any kind of contact with any inside part of this unit.

This symbol alerts the user that important literature concerning the operation and maintenance of this unit has been included. Therefore, it should be read carefully in order to avoid any problems.

Table of Contents

Use
Now!

Important Safeguards and Precautions	2
Before Using	4
• Accessories.....	4
• Loading the Batteries	4
• Record/Playback Time	4
• Prevent Accidental Tape Erasure ..	4
Connections (Outdoor Antenna Connections, DSS/Cable Box Connections)	5
One Time Setup (Language, Channel, Clock)	6, 7
TV Operation (Using the 100 key, Rapid Tune, Audio Mute, Phones, SELF-DEMO mode)	8
MTS Broadcast/TV Stereo System	9
• Stereo/SAP/Mono broadcast	9
• Select Audio mode for TV Viewing	9
Playback a Tape (Slow Motion, Still Picture, Frame by Frame, Features for Quality) ..	10
Record On a Tape	11
• One Touch Recording	11
• Selecting Input Mode	11

Enjoy
More!

Timer Recording (Review, Replace or Clear Program Contents)	12, 13
Timer Programming using VCR Plus+ System	14 ~ 17
• VCR Plus+ System	14
• VCR Plus+ System	14
Setup	15, 16
Programming	17
Copying Your Tapes (Dubbing)	18
TV Timer Features	19
• ON-TIMER with Alarm	19
• SLEEP TIMER	19
Closed Caption System	20
• Closed Caption Mode	20
• Caption on Mute	20
FM Radio	21
Tape Operation	22
• Repeat Play	22
• Zero Search	22
• One Minute Skip	22
• Auto Operation Functions	22
Special VCR Features	23
• Warning Beeper	23
• VCR Lock	23
Cable Box Universal Remote Control	24
Adjustment Features	25
• Picture Adjustment	25
• Audio Adjustment	25
<For Model PV-M2789 only>	25
Audio Features <For Model PV-M2789 only>	26, 27
• Speaker ON/OFF	27
• Spatializer	27

Other
Information!

On-Screen Display (OSD)	28
• VCR Status & Clock Display....	28
• Warning and Instruction	28
• Channel & Function Display	28
Displays	28
Unit Information	29
• Reset all Combination VCR	29
• Head Cleaning	29
Memory Functions	29
• Specifications	29
• DST (Daylight Saving Time)....	29
Before Requesting Service	30
Service Center List	31
Spanish (Español) Quick Use Guide	32 ~ 34
Warranty	35
Location of Controls	36, 37

Basic Operation

Advanced Operation

For Your Information

Before Using

Congratulations

on your purchase of one of the most sophisticated and reliable products on the market today. Used properly, it will bring you and your family years of enjoyment. Please fill in the information below. The serial number is on the tag located on the back of your Combination VCR.

Date of Purchase _____
 Dealer Purchased From _____
 Dealer Address _____
 Dealer Phone No. _____
 Model No. _____
 Serial No. _____

Accessories

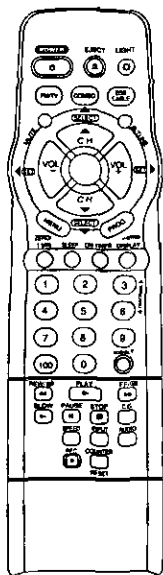

Remote Control
VSQS1608

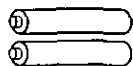

Batteries
2 "AA"

To order accessories,
call toll free 1-800-332-5368.

Loading the Batteries

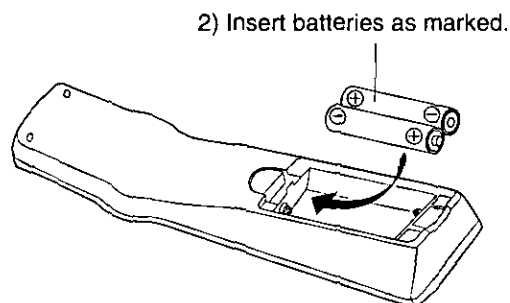
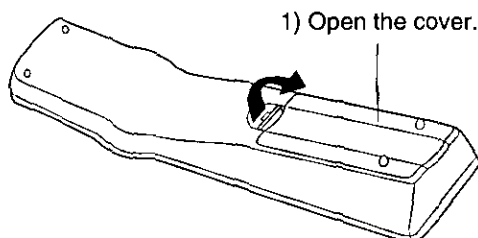

3) Close the cover.

- Battery replacement caution**
- Do not mix old and new batteries.
 - Do not mix alkaline with manganese batteries.

Prevent Accidental Tape Erasure

Break off the tab.

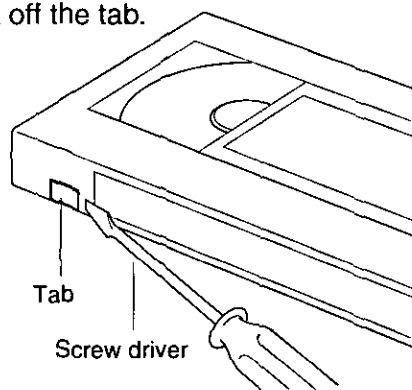

Record/Playback Time

Only use tapes with the **VHS** mark in this unit.

Tape Speed Setting	Type of Video Cassette		
	T60	T120	T160
SP (Standard Play)	1 Hour	2 Hours	2 Hours 40 minutes
LP (Long Play)	2 Hours	4 Hours	5 Hours 20 minutes
SLP (Super Long Play)	3 Hours	6 Hours	8 Hours

To record again.

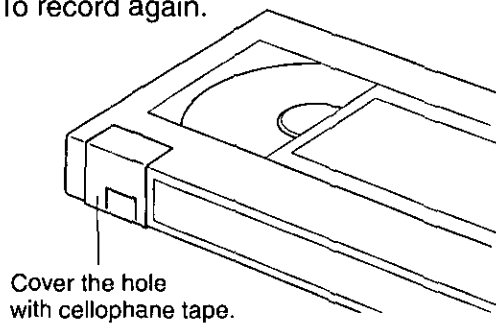

Outdoor Antenna Connections

Unhook the antenna from your previous TV or VCR and connect it to the back of the Combination VCR as shown in the diagram. If your antenna system has separate UHF and VHF leads, you need a UHF/VHF Band Mixer (not supplied.)

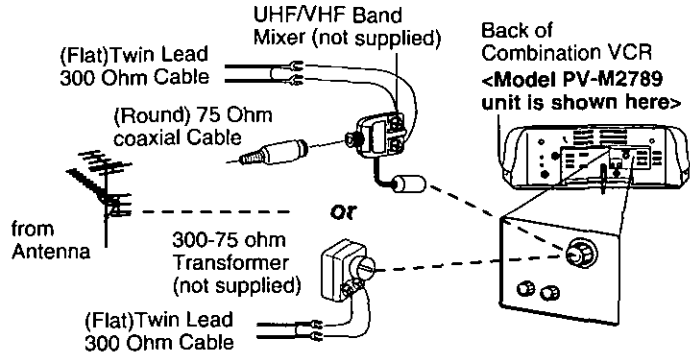

DSS/Cable box Connections

Without a Cable Box

- You can;
- record or view unscrambled channels.
- You cannot;
- record or view scrambled channels.
 - view a channel other than the one selected for any type of recording.

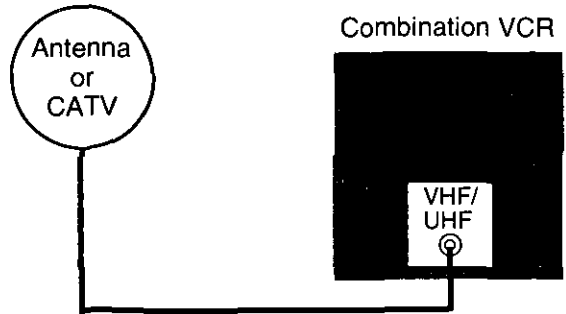

With a Cable Box

- You can;
- record or view any channel including scrambled channels.
- NOTE: Channel selection must be made at the cable box.
- You cannot;
- view a channel other than the one selected for any type of recording.
 - do a Timer recording of a channel unless you select it at the cable box.

Note to CATV System Installer

This reminder is provided to call the CATV (Cable TV) System Installers attention to Article 820-40 of the NEC that provides guidelines for proper grounding and, in particular, specifies that the cable ground shall be connected to the grounding system of the building, as close to the point of cable entry as practical.

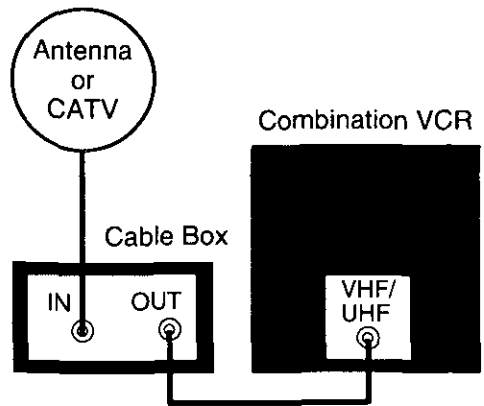

With a DSS Receiver

- You can;
- record or view any channel including scrambled channels.
- NOTE: Channel selection must be made at the DSS Receiver.
- You cannot;
- view a channel other than the one selected for any type of recording.
 - do a Timer recording of a channel unless you select it at the DSS box.

NOTE: The DSS receiver must be turned off to view programs from a cable box or antenna. See the DSS manual for details.

*DSS® is registered trademark of DIRECTV, INC., a unit of GM Hughes Electronics.

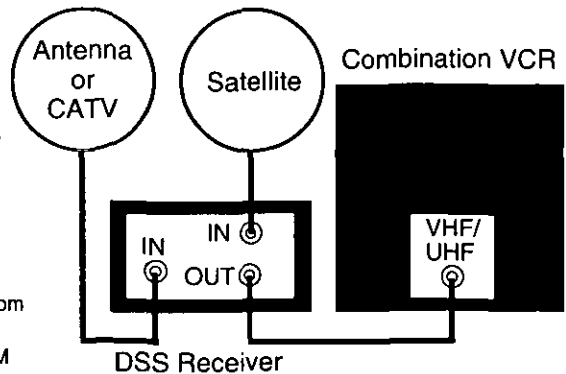

One Time Setup

When the Combination VCR is turned on the first time, setup mode is entered automatically.

Process of Setup



Language → Channel → Clock

1  **Press POWER* on the Combination VCR.**

2 **SELECT LANGUAGE**

PUSH CH ▲ : English
OPRIMIR CH ▼ : Español
APP. VOL + : Français

Select the language.

 for English
 for Spanish (Español)
 for French (Français)

- If wrong language is set, do "Reset all Combination VCR Memory Functions" steps page 29.
- If you use a cable box, the cable box must be left on.

3 **CHANNEL/CLOCK AUTO SET**

CONNECT ANTENNA CABLE AND IF YOU USE A CABLE BOX, TUNE IT TO YOUR LOCAL PBS CH THEN...

Start Channel Auto Set and Clock Auto Set.

PLEASE PUSH CH UP KEY

 **Press CH ▲.**

CH AUTO SET PROCEEDING

AUTO CLOCK SET PROCEEDING

Case 1 (Setup completed)

7/28/1999 WED 12:00PM
DST:ON
SETTING : CH 10
AUTO CLOCK SET COMPLETED
END : PUSH CH UP KEY

 **Press CH ▲ to exit.**

- If the displayed time and DST are not correct, please do "To Set or Reset the Clock" steps on the next page and select "MANUAL SET."

Case 2 (Setup incomplete)

AUTO CLOCK SET IS INCOMPLETE
PUSH MENU TO SET CLOCK

 **Set the clock manually.**

Press MENU and do "To Set or Reset the Clock" step 4 on the next page.

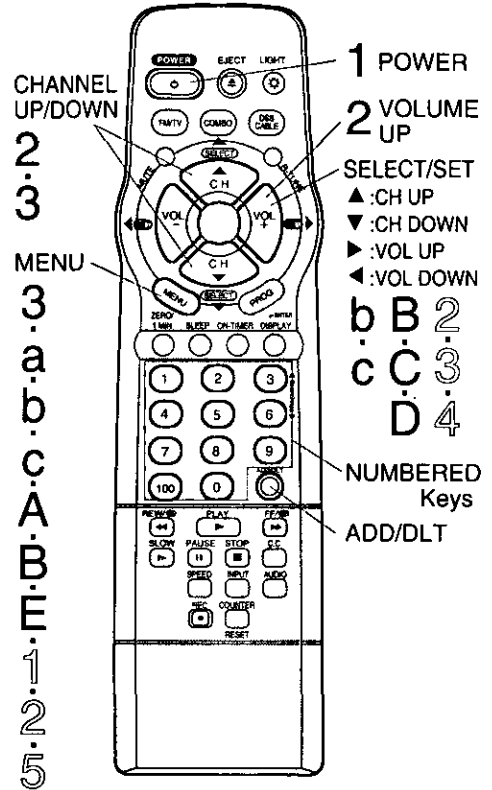

Using ▲▼◀▶ keys

 **On Remote**

- ▲ : CH UP
- ▼ : CH DOWN
- ▶ : VOLUME UP
- ◀ : VOLUME DOWN

 **On Unit**

Whenever the menu or program screen is displayed, CHANNEL UP/DOWN and VOLUME UP/DOWN function as ▲▼◀▶ only.

IMPORTANT NOTE FOR AUTO CLOCK SET



- Auto clock set is performed the first time when Combination VCR is turned off each day. If used, a cable box must be left on and tuned to the PBS channel at the time Combination VCR power is turned off if you want auto clock set to be done.
- If using, a DSS receiver, must be turned off for auto clock set.
- If Cable Box or DSS receiver is connected to Combination VCR via Audio/Video Jacks, an RF coaxial cable must also be connected for auto clock set and channel auto set features.
- If, for any reason, the time is changed manually, automatic time correction will not occur.

* Important: If remote control POWER, CH Up/down, MENU, PROG, DISPLAY, ON-TIMER, R-TUNE, FM/TV, or ADD/DLT button does not work when pressed, press COMBO button on the remote and try the button again.

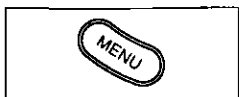
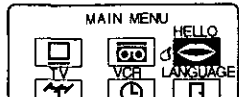
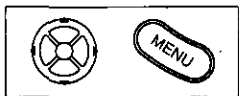

To Change the OSD Language

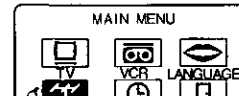
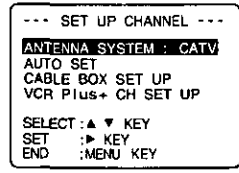
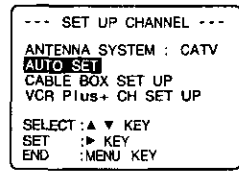
- a**  **Display MAIN MENU.**
Press MENU.
- b**  **Select the language selection icon.**
1) Press ▲▼◀▶ to select.
English:LANGUAGE
Spanish:IDIOMA
French:LANGUE
2) Press MENU repeatedly to set.
- c**  **End setup.**
1) Press ▲▼◀▶ to select "EXIT."
2) Press MENU to exit.

To Replace Channels in Memory

- A**  **Display MAIN MENU.**
Press MENU.
- B**  **Display SET UP CH screen.**
1) Press ▲▼◀▶ to select "CH."
2) Press MENU to display.
- C**  **Select ANTENNA.**
1) Press ▲▼ to select.
2) Press ► to select your antenna system ("TV" or "CATV").
- D**  **Select AUTO SET.**
1) Press ▲▼ to select.
2) Press ► to start.
- E**  **End setup.**
Press MENU twice.

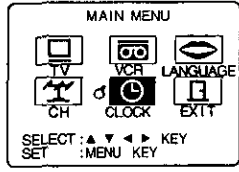
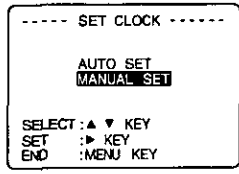
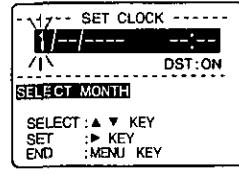
To Set or Reset the Clock

- 1**  **Display MAIN MENU.**
Press MENU.
- 2**  **Display SET CLOCK screen.**
1) Press ▲▼◀▶ to select "CLOCK."
2) Press MENU.
- 3**  **Display MANUAL screen.**
1) Press ▲▼ to select "MANUAL SET."
2) Press ► to set.
- For Auto Clock Set, select "AUTO SET" then press ► to set and CH ▲ to start.
- 4**  **Set the clock manually.**
1) Press ▲▼ to select the month.
2) Press ► to set.
- Likewise set date, year, time, and DST. (Daylight Saving Time.)
- To Make Corrections,**
repeatedly press ◀▶ to move to error, then correct.
- 5**  **End setup.**
Press MENU twice to start the clock and exit this mode.

Add or Delete a Channel

To add channel:
Select channel with NUMBERED keys and press ADD/DLT.

To delete channel:
Select channel with CH▲▼ or NUMBERED keys and press ADD/DLT.

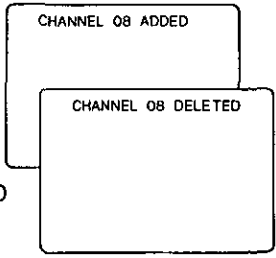

- Notes**
- This Combination VCR calendar is accurately maintained up to Dec. 31, 2089, 11:59PM.
 - Channel auto set selects normal TV or Cable channels depending on your Combination VCR hookup.

TV Operation

*Important: If the remote control POWER, CH Up/Down, MENU, PROG, DISPLAY, ON-TIMER, R-TUNE, FM/TV, or ADD/HLT button does not work when pressed, press COMBO button on the remote and try the button again.

1



Press **POWER*** on the Combination VCR.



Check list before you begin.

- All connections are made (see page 5.)
- Your Combination VCR is plugged in.

2

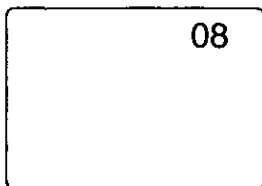

Select a channel.

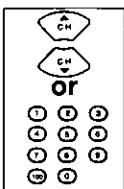

Using CH ▲▼ or NUMBERED keys.

Model PV-M2789 unit is shown here.

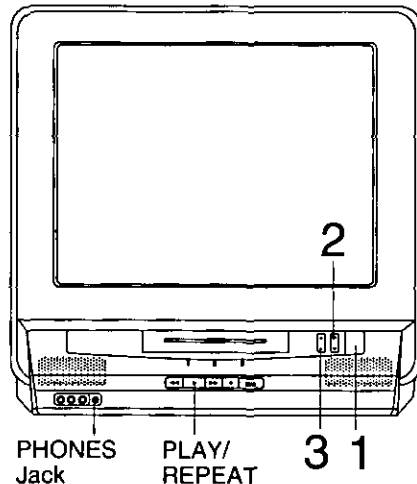

3



Adjust volume.

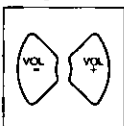

Press VOL+/-.

■ Using the 100 key

When selecting CATV channels 100 to 125 with the NUMBERED keys, first press the 100 key, and then enter the remaining two digits.

■ Rapid Tune

Press R-TUNE to display the last channel you were watching.

■ Audio Mute

Press MUTE to instantly mute the sound.
Press again, to restore the previous sound level.

■ Phones

Connect an earphone (not supplied) or headphones (not supplied) to the Phones Jack.

■ SELF-DEMO Mode

With Power ON, hold down PLAY/REPEAT on the Combination VCR, with no tape inserted for 5 seconds, to display demo screen.
Repeat this to exit.

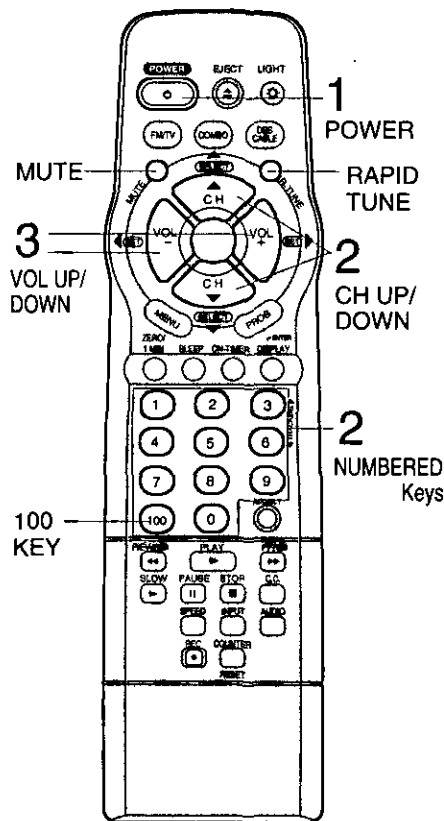

MTS Broadcast/TV Stereo System

Receivable Broadcast Types

The following are possible broadcast types with their accompanying on-screen displays. The signal being received is indicated with an "Ⓚ" mark while the selected audio mode is indicated with an arrow. To change the audio mode for these broadcasts, follow the "Select Audio Mode for TV Viewing" section (below.)

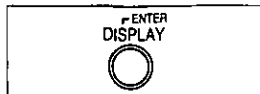

Display the broadcast signal being received.

Press DISPLAY to display.

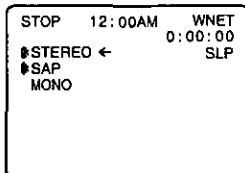

MTS Stereo and SAP broadcast
Multi-channel Television Sound Stereo (main language) and Secondary Audio Program (sub language) broadcasts are both being received simultaneously. Select the STEREO or SAP audio mode.

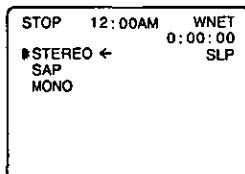

MTS Stereo broadcast
Multi-channel Television Sound Stereo broadcast. Select STEREO audio mode.
• If stereo broadcast is weak and the display flickers, select MONO audio mode for possibly better results.

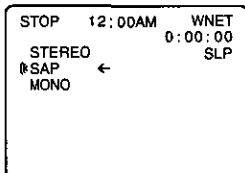

SAP broadcast
Secondary Audio Program (sub language.) Select SAP audio mode for the sub language.

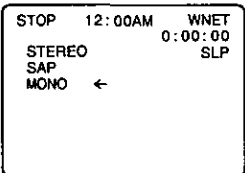

MONO broadcast
Normal monaural sound broadcast.

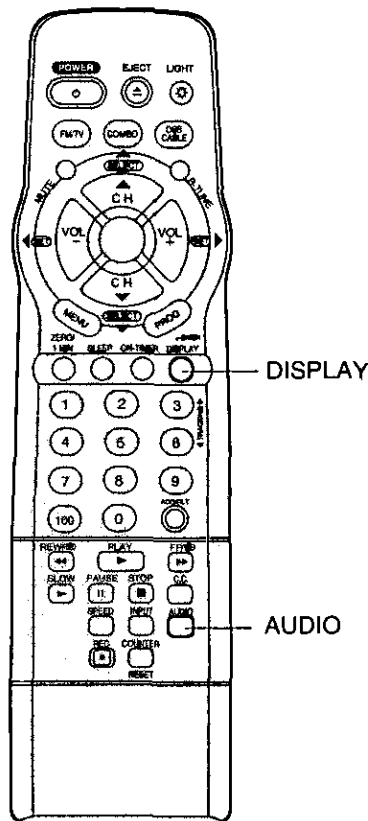

Select Audio Mode for TV Viewing



Press AUDIO to select the desired audio mode as described above. (Arrow shows selection.)

- Each press of AUDIO will change the audio mode as shown below.

< Example >

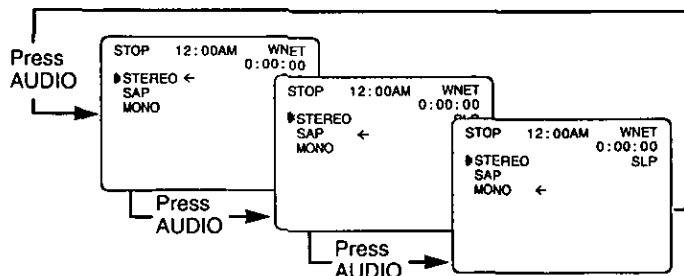

IMPORTANT NOTE:
<For model PV-M2759 only>
This stereo system is designed for TV viewing only. Recording and playback will always be in monaural.

Playback a Tape

*Important: If the remote control POWER, CH Up/Down, MENU, PROG, DISPLAY, ON-TIMER, R-TUNE, FM/TV, or ADD/DLT button does not work when pressed, press COMBO button on the remote and try the button again.

Model PV-M2789 unit is shown here.

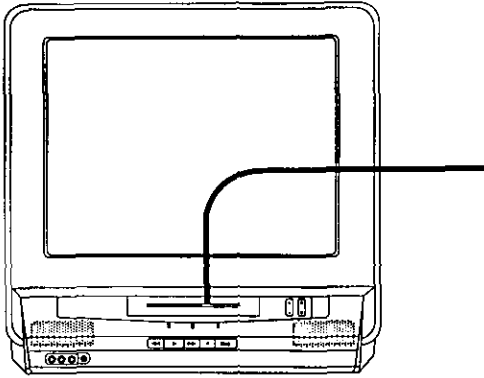

Check list before you begin.

- All connections are made (see page 5.)
- Your Combination VCR is plugged in.

1

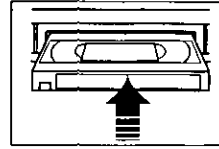

Insert a cassette.

- Combination VCR power comes on automatically.

Note

To prevent tape jam

Inspect your cassette tapes and remove any loose or peeling labels.

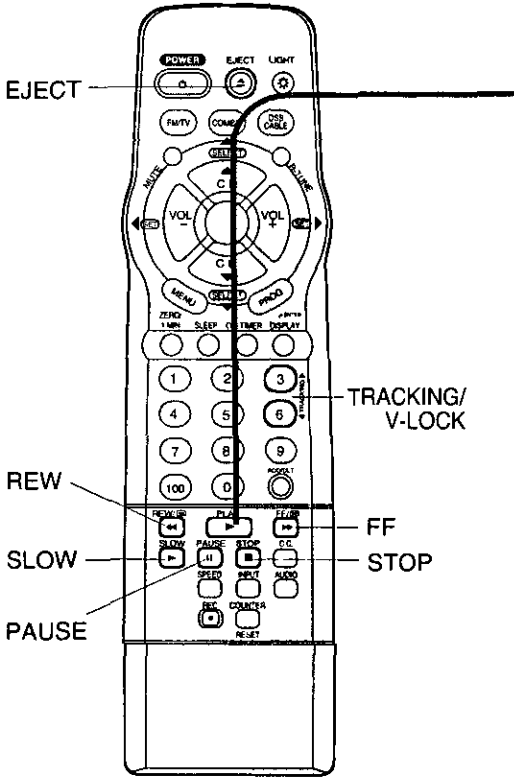
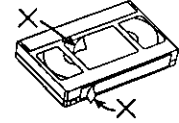

2



Press PLAY.

- Playback begins if cassette has no record tab.

■ To Find a Particular Scene

- Forward Search → Press FF
- Reverse Search → Press REW

■ For view Slow Motion → Press SLOW

(To release, press SLOW)

■ For view Still (Freeze) picture → Press PAUSE

(To release, press PAUSE)

■ For view Frame by Frame picture →

Press SLOW in the Still mode (To release, press PAUSE)

Note

After Combination VCR is in Still or Slow mode for 3 minutes, it will switch to Stop mode automatically to protect the tape and the video head.

■ To stop → Press STOP

■ To rewind tape → Press REW in stop mode

■ To eject tape → Press EJECT on the remote or STOP/EJECT on the Combination VCR

You can operate on the Combination VCR (Model PV-M2789 unit is shown here.)

1 Insert a cassette.

2 Press PLAY.

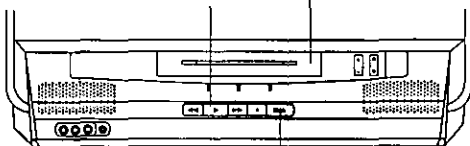

- Press to stop and/or eject tape.

Features for Quality Picture

Digital Auto Tracking

Continuously analyzes the signal and adjusts for optimum picture quality.

Manual Tracking Control (to reduce picture noise)

Use during Playback and Slow Motion mode to reduce picture noise.

Press the 3 or 6 NUMBERED key on the remote control or CH ▲▼ * on the Combination VCR until the picture clears up. To return to Auto Tracking, press POWER off, then on again a few seconds later.

V-Lock Control <For Model PV-M2789 only>

In Still mode, the 3 or 6 NUMBERED key on the remote control or CH ▲▼ on the Combination VCR operate as a V-Lock control to reduce jitter.

PanaBlack™ Picture Tube

This Combination VCR uses a PanaBlack™ picture tube for better color reproduction and picture contrast.

Record On a Tape

Model PV-M2789 unit is shown here.

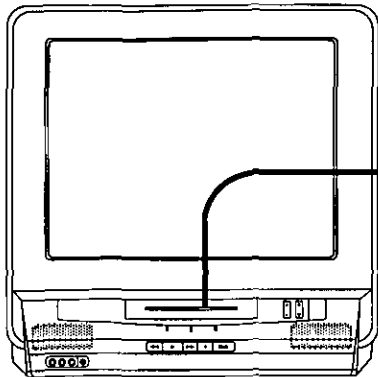

Check list before you begin.

- All connections are made (see page 5.)
- Your Combination VCR is plugged in.
- Cassette with record tab in place.

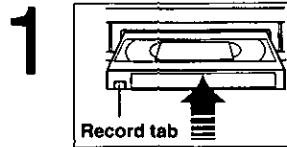

Insert a cassette.

- Combination VCR power comes on automatically.

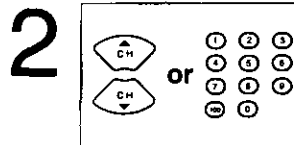

Select Channel.

Press CH ▲▼, or NUMBERED keys.

- To select "LINE," see bottom of this page.

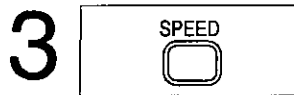

Select Recording speed (see page 4.)

Press SPEED.

- SP = Standard Play
- LP = Long Play
- SLP = Super Long Play
- Selected speed is displayed.



Start Recording.

Press REC.

- To edit out unwanted portions, press PAUSE to pause and resume recording.
- You can not view another channel during recording.

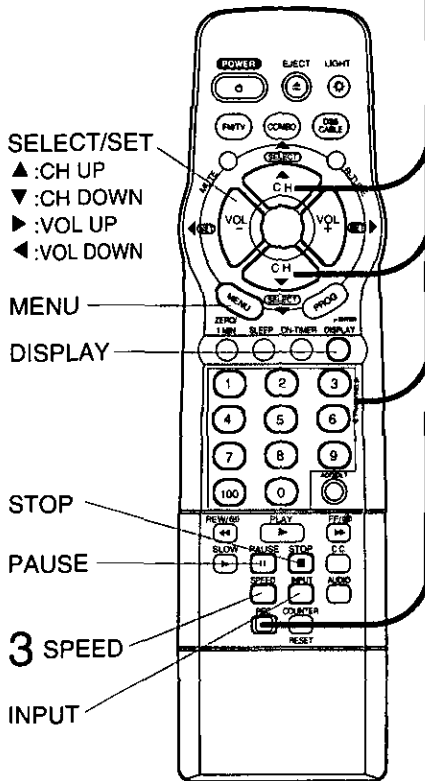

■ To stop → Press STOP

■ One Touch Recording (OTR)

Press REC repeatedly to set the recording length (30 min - 4 hours.)

- Combination VCR stops recording at a preset time.
- PROG TIMER indicator lights on the Combination VCR.

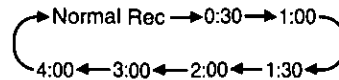

Notes

- After Combination VCR has been in Rec Pause mode for 5 minutes, it will stop automatically to protect the tape and video head.
- The remaining recording time of an OTR can be displayed by pressing DISPLAY.

Selecting Input Mode

Method 1:
Press INPUT. Channel Number <---> LINE

Method 2:
Press CH ▲▼. The display will change as follows.

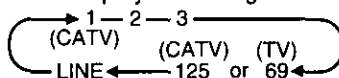

- Method 3:
- a Press MENU for MAIN MENU.
 - b Press ▲▼◀▶ to select "TV", then press MENU for SET UP TV screen.
 - c Press ▲▼ to select "INPUT SELECT," and then press ▶ to select "TUNER" or "LINE."
 - d Press MENU twice to exit this mode.

You can operate on the Combination VCR (Model PV-M2789 unit is shown here.)

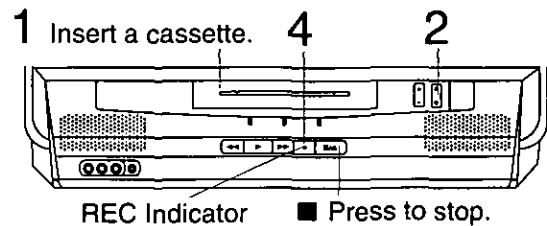

Timer Recording

You can set up to 8 programs to be recorded while you are away.

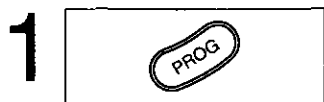

Display SET PROGRAM.
Press PROG*.

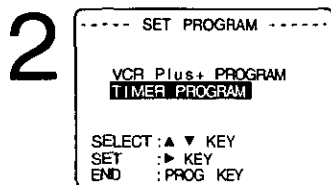

Select TIMER PROGRAM.

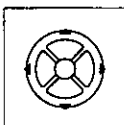

- 1) Press ▲▼ to select.
- 2) Press ► to display.

• If a program is already in memory, press ▲▼, and ► to select an unused program number.

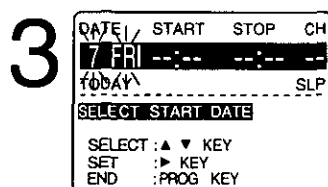

Set the recording DATE.

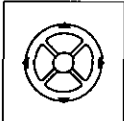

- 1) Press ▲▼ to select.
- 2) Press ► or ◀ to set.

- 1-31 = One time
- DAILY = MON-FRI
- WEEKLY SUN-SAT = Same time once a week

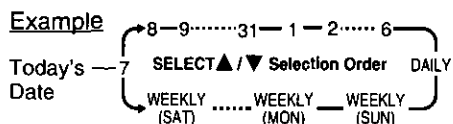

Repeat step 3 to set:

- start time, stop time
- Channel (or LINE for outside source)
- Speed (SP, LP, SLP)

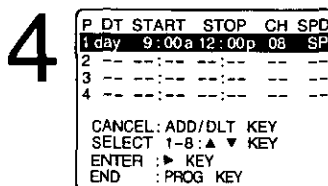

End the program.

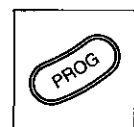

Press PROG.

To Enter More Programs

Press ▲▼ and ► to select and set a blank program number, and then repeat steps 3 and 4.



Exit this mode.

Press PROG twice.

- If you're using a cable box, make sure that it is tuned to the desired channel and the power is left on for timer recording.
- PROG TIMER indicator lights on the Combination VCR.

Check list before you begin.

- All connections are made (see page 5.)
- Your Combination VCR is plugged in.
- The clock is set to correct time.
- The tape is long enough.
- The record tab is in place.

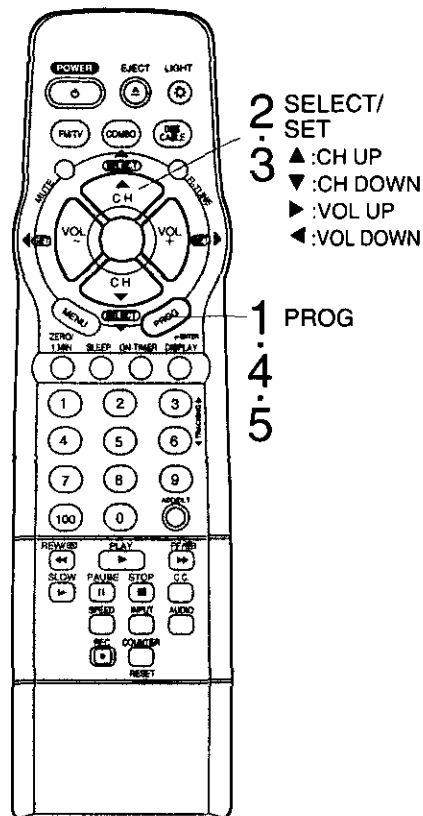

Notes

- If "PLEASE PREPARE FOR TIMER REC" appears and/or the PROG TIMER indicator flashes, check that a cassette with record tab is loaded and the Combination VCR is in Stop mode.
- If the start times of two programs overlap, the lower numbered program will have priority.
- If the start time for a Timer Recording comes up during a normal recording or One Touch Recording (page 11), the Timer Recording will not be performed.
- If there is a power interruption of more than one minute, the recording may not be performed or continue.
- If "INCOMPLETE" appears after all items have been set, check all entries and make necessary corrections.

*Important: If the remote control POWER, CH Up/Down, MENU, PROG, DISPLAY, ON-TIMER, R-TUNE, FM/TV, or ADD/DLT button does not work when pressed, press COMBO button on the remote and try the button again.

Review, Replace or Clear Program Contents: (Recording is not in progress)

a Repeat steps 1 and 2 on page 12.

b

P	DT	START	STOP	CH	SPD
1	day	9:00a	12:00p	08	SLP
2	8	10:00p	11:00p	125	SLP
3	10	8:00p	9:00p	10	SLP
4	SU	9:00p	10:00p	L	SLP

CANCEL: ADD/DLT KEY
 SELECT 1-8: ▲ ▼ KEY
 ENTER: ► KEY
 END: PROG KEY

Select the desired program.

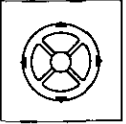

Press ▲▼ to select.

c To Replace program...

DATE	START	STOP	CH
8 SAT	10:00P	11:00P	125
7/17/11			SLP

SELECT START DATE

SELECT: ▲ ▼ KEY
 SET: ► KEY
 END: PROG KEY

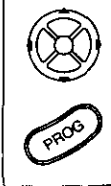

- 1) Press ► to display.
- 2) Press ▲▼◀▶ to set new program contents.
- 3) Press PROG.

To Clear program...

P	DT	START	STOP	CH	SPD
1	--	--	--	--	--
2	8	10:00p	11:00p	125	SLP
3	10	8:00p	9:00p	10	SLP
4	SU	9:00p	10:00p	L	SLP

SELECT 1-8: ▲ ▼ KEY
 ENTER: ► KEY
 END: PROG KEY

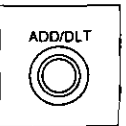

Press ADD/DLT.



Exit this mode.
Press PROG twice.

Cancel a Timer Recording: (Recording is in progress)

Hold down STOP for a few seconds to cancel the Timer Recording.

- Any future daily or weekly recordings will be performed as programmed.

Model PV-M2789 unit is shown here.

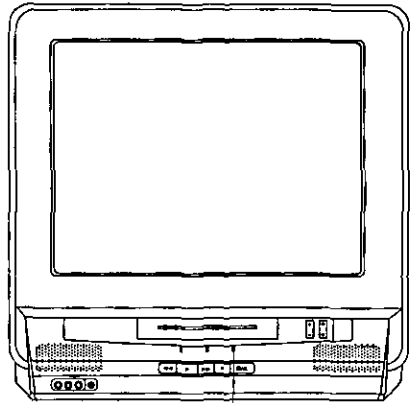

PROG TIMER indicator

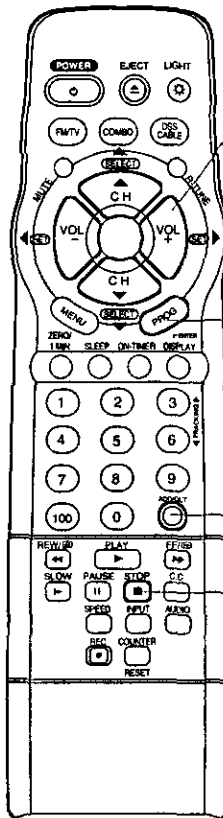

b SELECT/SET
b.c ▲: CH UP
 ▼: CH DOWN
 ►: VOL UP
 ◀: VOL DOWN

c PROG
d

c ADD/DLT

STOP

Timer Programming using VCR Plus+ System

VCR Plus+ System is...

a feature that allows you to set most items of a Timer Recording by simply entering a special code number (PlusCode) found in TV GUIDE and selected newspaper TV listings.

Process of Recording

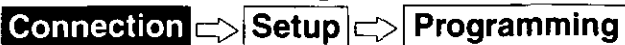

Choose your connection type from the following diagrams

■ CABLE BOX → COMBINATION VCR

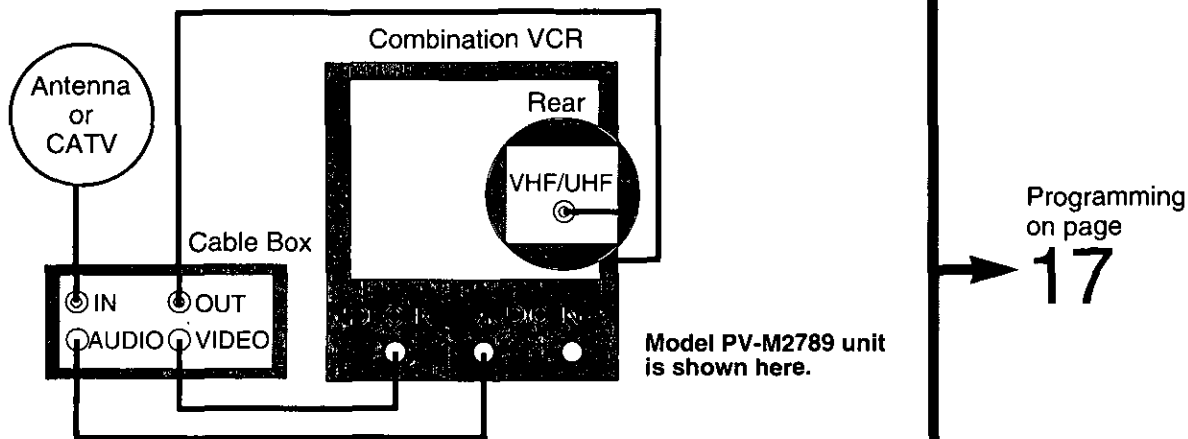
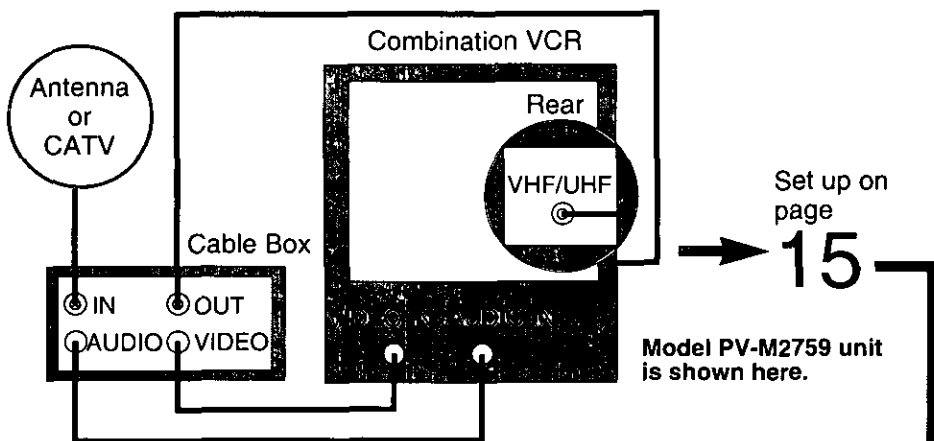

■ ANTENNA or CABLE → COMBINATION VCR



*Important: If the remote control POWER, CH Up/Down, MENU, PROG, DISPLAY, ON-TIMER, R-TUNE, FM/TV, or ADD/HLT button does not work when pressed, press COMBO button on the remote and try the button again.

Cable Box Setup

Process of Recording

Connection → Setup → Programming

1  **Display MAIN MENU.**
Press MENU*.

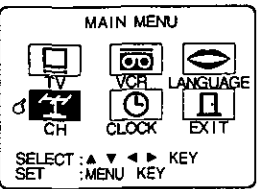
2  **Display SET UP CH screen.**
1) Press ▲▼◀▶ to select "CH."
2) Press MENU to display.

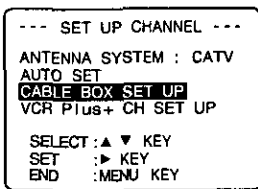
3  **Select CABLE BOX SET UP.**
1) Press ▲▼ to select.
2) Press ▶ to display.

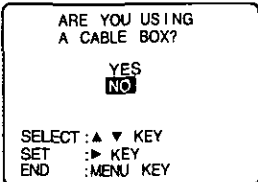
4  **Select "YES" or "NO".**
1) Press ▲▼ to select "YES" or "NO."
2) Press ▶ to set.

If you select...

- "YES" → Step 5.
- "NO" → Press MENU → Go to VCR Plus+ Channel Setup on page 16.

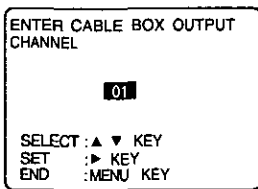
5  **Select Cable box output channel number.**
1) Press ▲▼ to select.
2) Press ▶ to enter.

- If necessary, refer to your cable box manual.
- If you are using Audio/Video jack connection for your cable box, select and set "VIDEO OUT" as the output channel.

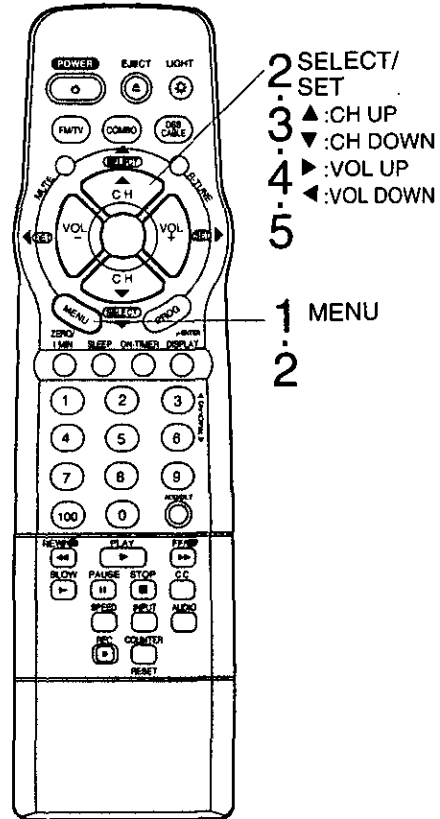

Advanced Operation

VCR Plus+ and PlusCode are registered trademarks of Gemstar Development Corporation. The VCR Plus+ system is manufactured under license from Gemstar Development Corporation.

Timer Programming using VCR Plus+ System

VCR Plus+ Channel Setup is...

necessary to program the Combination VCR with local channel information for proper VCR Plus+ operation.

Process of Recording



VCR Plus+ Channel Setup

At first, do Channel Setup Preparations below right.

1



Display MAIN MENU.
Press MENU*.

2

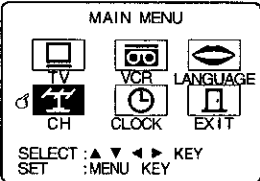

Display SET UP CH screen.

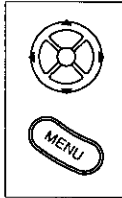

- 1) Press ▲▼◀▶ to select "CH."
- 2) Press MENU to display.

3

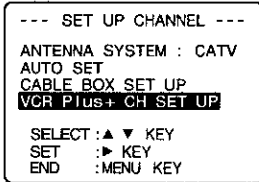

Select VCR Plus+ CH SET UP.

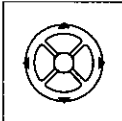

- 1) Press ▲▼ to select.
- 2) Press ▶ to display.

4

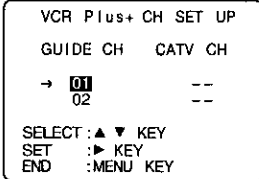

Enter VCR Plus+ channels.

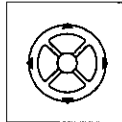

- 1) Press ▶ to move cursor to right column.
- 2) Press ▲▼ to change the CATV CH number.
- 3) Press ◀ to set.
- 4) Press ▲▼ to scroll up/down the GUIDE CH column.

• Repeat step 4 until list is complete.

To Make Corrections

Press ▲▼ and ▶ to move to error, then ▲▼ to change, or ADD/DLT to erase number.

5



End the setup.

Press MENU three times.

Notes

- Make each entry within 5 minutes or the Combination VCR will leave this mode.
- Once local channels have been programmed, they will stay in memory, even in the case of a power failure.

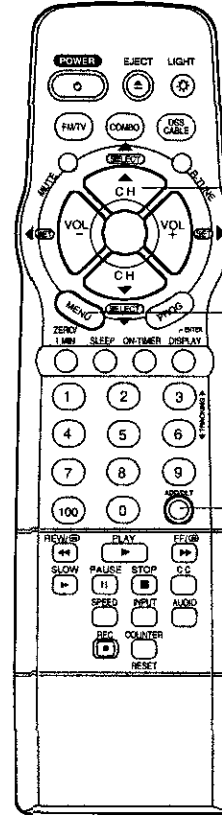

- 2 SELECT/SET
- 3 ▲: CH UP
- 4 ▼: CH DOWN
- ▶: VOL UP
- ◀: VOL DOWN
- 1 MENU
- 2
- 5

ADD/DLT

Channel Setup Preparations

To complete step 4 left, make a local channel list (see example below.)

You will need the following:

- A normal TV and/or Cable stations line up and the channel numbers you receive them on.
- A list of Guide (VCR Plus+) channel numbers for stations you receive (see TV Guide and selected newspapers.)

- 1 Make a 3-column chart. In the left column, write all station names you receive.
- 2 In the middle column, write each station's Guide (VCR Plus+) number.
- 3 In the right column, write the channel number your TV receives the station on.

< EXAMPLE ONLY >

Broadcast or Cable Station Name	Assigned Guide (VCR Plus+) Channel No.	Channel No. your TV receives the station on
HBO	33	15
Nickelodeon	38	20
CBS	34	04
FOX	11	

*Important: If the remote POWER, CH Up/Down, MENU, PROG, DISPLAY, ON-TIMER, R-TUNE, FM/TV, or ADD/DLT button does not work when pressed, press COMBO button on the remote and try the button again.

VCR Plus+ System Programming

Process of Recording

Connection → Setup → **Programming**

1  **Display SET PROGRAM.**
Press PROG.

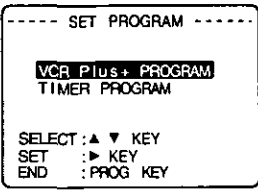
2  **Select VCR Plus+ PROGRAM.**
1) Press ▲▼ to select.
2) Press ► to display.

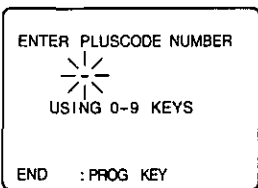
3  **Enter PlusCode programming number.**
1) Press NUMBERED keys.
2) Press PROG when finished.

To Make Corrections
Press ◀ repeatedly to delete the PlusCode programming number.

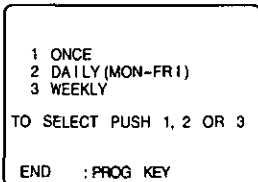
4  **Set Record Frequency.**
Press 1, 2 or 3 to set.
1 → One time
2 → Daily
3 → Weekly

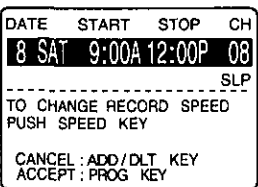
5  **Select Recording speed (See page 4.)**
Press SPEED.
SP = Standard Play
LP = Long Play
SLP = Super Long Play

To cancel Program Contents
Press ADD/DLT.

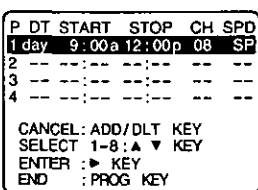
6  **End programming.**
Press PROG.

7  **Exit this mode.**
Press PROG twice.
• PROG TIMER indicator lights on the Combination VCR.

Before you begin, make sure...

- The clock is set to correct time.
- VCR Plus+ System Setup is complete (See pages 15, 16.)

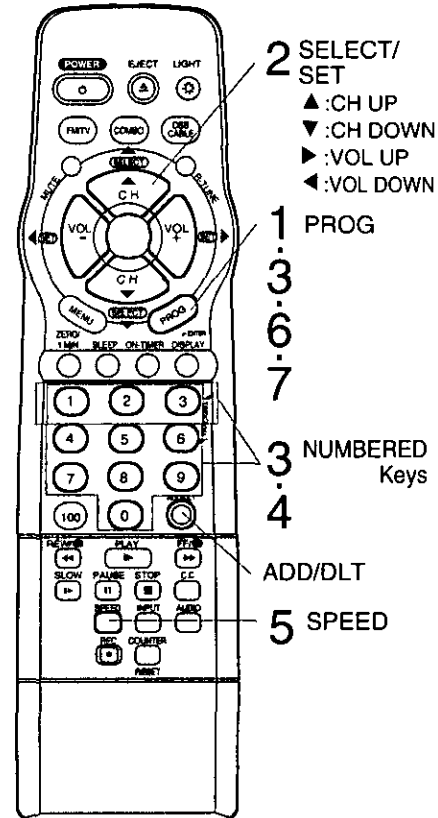

Advanced Operation

Use normal Timer Recording steps if:

- a program PlusCode programming number is not listed.
- program, such as sporting event, may run over scheduled stop time.

See page 13 to:

- cancel a timer recording in progress.
- replace program contents.
- review or clear program contents once set.

Notes

- You can obtain unlisted PlusCode programming numbers by calling 1-900-454-7587. Call costs approximately \$.95 per minute.
- Avoid overlapping program times.
- If you're using a cable box, make sure that it is tuned to the desired channel and the power is left on for timer recording.

Copying Your Tapes (Dubbing)

Connections you'll need to make.

Model PV-M2759 unit is shown here.

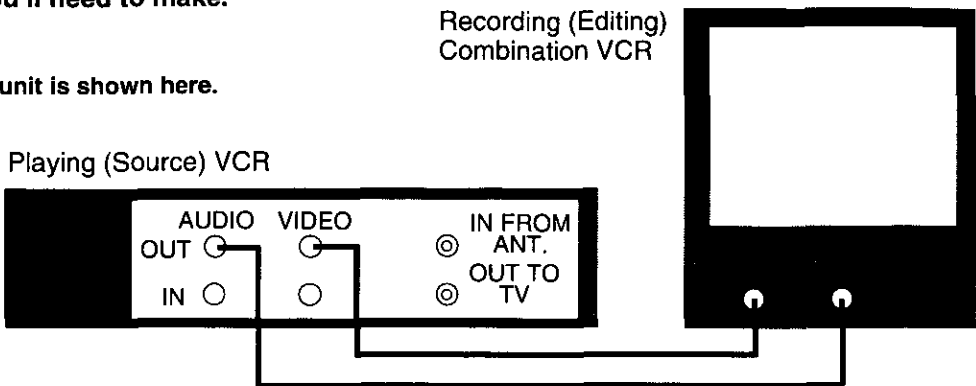

Model PV-M2789 unit is shown here.

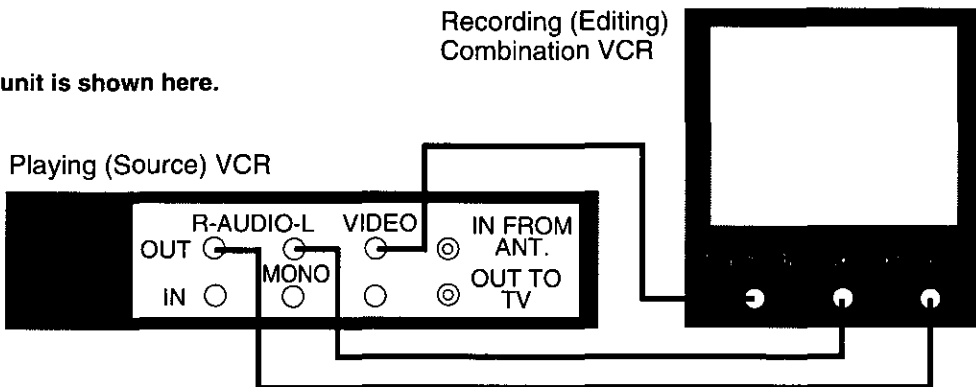

Playback (Source) VCR

Recording (Editing) Combination VCR

1

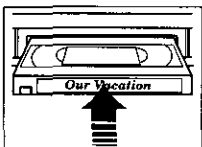

Insert pre-recorded tape.

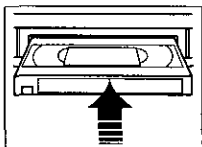

Insert blank tape with record tab.

• Dubbing tapes protected with Copy Guard will have poor quality results.

2

Select "LINE" mode.

See "Selecting Input Mode" section on page 11.

3

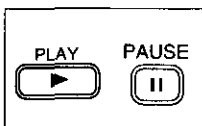

Put in Standby mode.

Press PLAY then PAUSE at starting point.

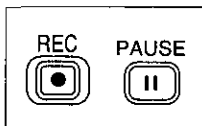

Put in Standby mode.

Press REC, then PAUSE immediately.

4

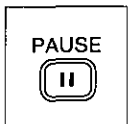

Start dubbing.
Press PAUSE.

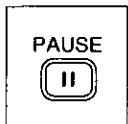

Start dubbing.
Press PAUSE.

5

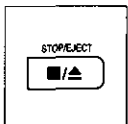

Stop dubbing.
Press STOP/EJECT.

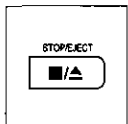

Stop dubbing.
Press STOP/EJECT.

Caution: Unauthorized exchanging and/or copying of copyrighted recordings may be copyright infringement.

TV Timer Features

* Important: If the remote control POWER, CH Up/Down, MENU, PROG, DISPLAY, ON-TIMER, R-TUNE, FM/TV, or ADD/DLT button does not work when pressed, press COMBO button on the remote and try the button again.

ON-TIMER with Alarm

Combination VCR can be set to automatically power on in one of 3 modes (TV, Playback, or FM radio.) You can also combine the On-Timer with a one minute alarm that gradually increases in volume.

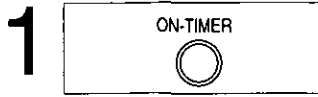

Display ON TIMER screen.

Press ON-TIMER*.

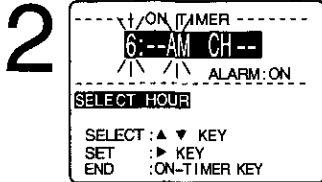

Set the ON-TIMER DATE.



- 1) Press ▲▼ to select.
 - 2) Press ► to set.
- Make sure a tape is inserted if Playback mode is selected.
 - See "FM Radio" on page 21 for instructions on how to preset FM stations.

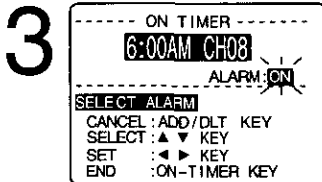
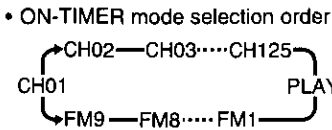

Set Alarm.

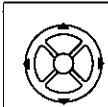

Press ▲▼ to select "ON" or "OFF."

When "ON" is selected, an alarm will gradually increase in volume for one minute or until cancelled by pressing any button (including VOL ◀▶.)

To Make Corrections, use ▲▼ and ◀▶ to move back and correct as necessary.

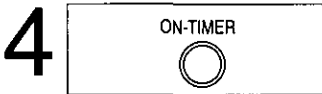

Set ON TIMER.

Press ON-TIMER.

- ON TIMER indicator lights on the Combination VCR.

To cancel ON-TIMER set, press ON-TIMER to redisplay the screen in step 3. Then, press ADD/DLT to clear the time ("6" is flashing.) Now, press ON-TIMER to end. "ON TIMER END" appears on-screen for a few seconds.

Note

If no button on the remote or Combination VCR (including a button used to turn off the alarm) is pressed within 60 minutes after Combination VCR turns itself on, it will turn itself back off.

SLEEP TIMER

Combination VCR can be set for auto power off:

- SLEEP TIMER 30
- SLEEP TIMER 60
- SLEEP TIMER 90
- SLEEP TIMER 00

Set SLEEP TIMER.

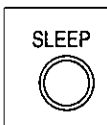

Press SLEEP repeatedly.

- Pressing DISPLAY with sleep timer set displays remaining time.

To Cancel, press SLEEP repeatedly until "SLEEP TIMER 00" appears.

Check list before you begin.

- The clock is set to correct time.

Model PV-M2789 unit is shown here.

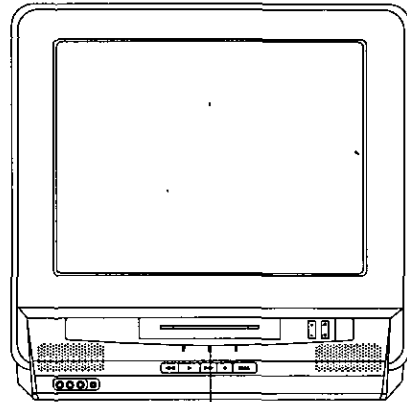

ON TIMER Indicator

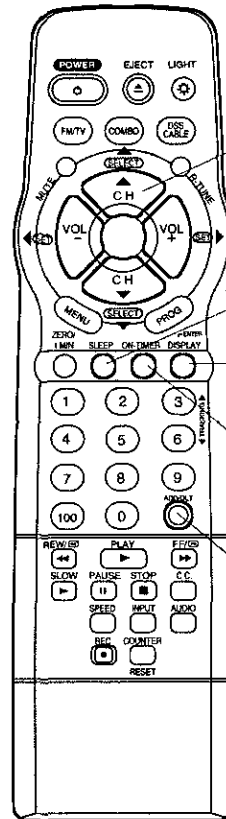

- 2 SELECT/SET
- 3 ▲:CH UP
▼:CH DOWN
►:VOL UP
◄:VOL DOWN
- SLEEP
- DISPLAY
- 1 ON-TIMER
- 4 ADD/DLT

Advanced Operation

Closed Caption System

Closed Caption Mode

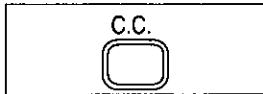

Select CAPTION MODE.

Press C.C.

- Each press C.C. will change the display as shown at left.

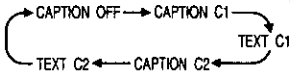

Recording and Playing Back a Closed Caption/Text Program

Record: Record normally. Closed Caption/Text signal, if present, is recorded automatically.

Playback: Start playback. Press C.C. repeatedly to display desired caption mode.

Caption On Mute

Closed Caption narration, if available, is displayed when MUTE button is pressed for silence.

1

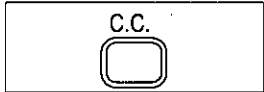

Display CAPTION OFF.

Press C.C. until CAPTION OFF is displayed on screen.

2



Display MAIN MENU.

Press MENU*.

3

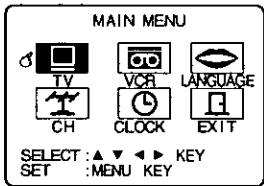

Display SET UP TV screen.

- 1) Press ▲▼◀▶ to select "TV."
- 2) Press MENU to display.

4

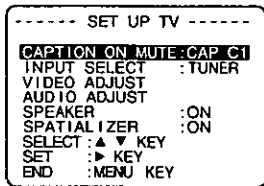

Select CAPTION ON MUTE.

- 1) Press ▲▼ to select.
- 2) Press ▶ repeatedly to select desired caption mode.

<For model PV-M2789 only>

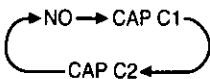

- Each press of ▶ will change the display as shown at left.
- The caption may be broadcast over CAP C1 or C2.

5



Return to the normal screen.

Press MENU twice.

6



Mute sound, display closed captioning.

Press MUTE to mute the sound.

- To cancel, press MUTE again.

Closed Caption is ...

This multi-use system not only allows the hearing impaired to enjoy selected programs, but also makes useful information from TV stations available to everyone.

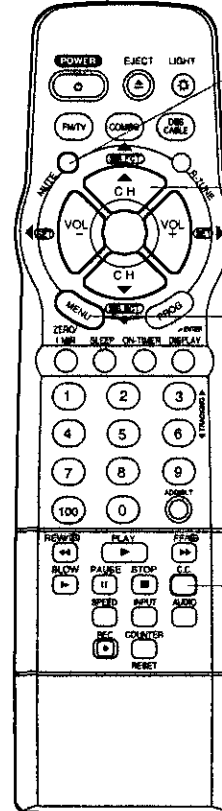

6 MUTE

2 SELECT/SET

3 ▲:CH UP
▼:CH DOWN

4 ▶:VOL UP
◀:VOL DOWN

2 MENU

3

5

1 C.C.

Closed Caption Modes From which to Choose

Caption Mode: CAP C1 or C2

A narration of selected TV programs is displayed.

Check TV program listings for C.C. (Closed Caption) broadcasts.

Caption Mode: TEXT C1 or C2

The lower half of the screen will be blocked out. When the TV station broadcasts information, such as program listings, it will appear in this space.

Caption Mode: OFF

Closed Caption/Text narration will not be displayed.

NOTE:

The closed caption or text signal may be broadcast over C1, C2, or both. Also, text contents can vary so you may wish to try different settings.

FM Radio

* Important: If the remote control POWER, CH Up/Down, MENU, PROG, DISPLAY, ON-TIMER, R-TUNE, FM/TV, or ADD/DLT button does not work when pressed, press COMBO button on the remote and try the button again.

FM Radio Setup

1  **Display FM radio mode.**
Press FM/TV.

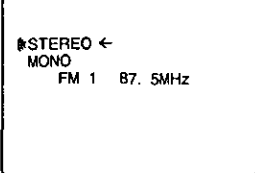
2  **Select the FM number.**
Press a **NUMBERED** key (1~9.)

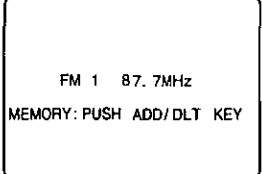
3  **Set the radio station.**

 1) Press ▲▼ to select the desired radio station. (Each press changes frequency 200 KHz.)

 2) Press ADD/DLT to set.

• To preset other stations, repeat steps 2 and 3.



To Make Corrections, select station with a NUMBERED key, then do step 3 again.

To exit FM mode, press FM/TV.

Using FM Radio

a  **Display FM radio mode.**
Press FM/TV.

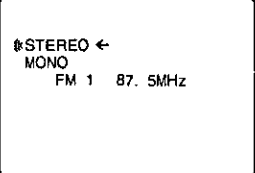
b  **Select the FM number.**
Press a **NUMBERED** key (1~9) to select a preset station (see steps 1~3 above.)

To cancel, press FM/TV again.

FM Radio is...

The Combination VCR has an FM radio with built-in antenna, 9 station preset, and a band range of 87.5~108.1 MHz. You can even set the On-Timer (page 19) to wake up to your favorite radio station.

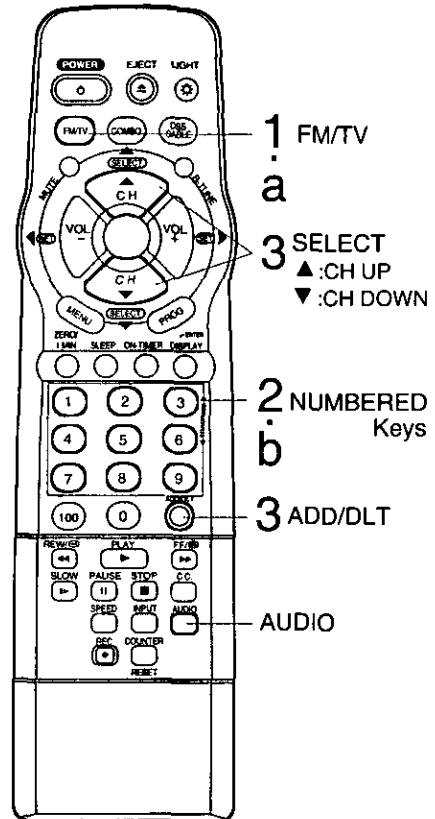



Advanced Operation

Notes

- FM radio stations cannot be recorded on a Video cassette.
- You may get better reception by repositioning the Combination VCR.
- You cannot select FM Radio mode during playback or record, or while a blue back screen (MENU, PROG, and ON-TIMER) is displayed.

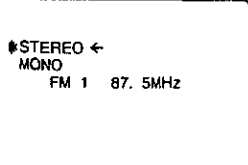
To select Audio Mode for FM Radio

 **Select "STEREO" or "MONO."**
Press **AUDIO** repeatedly in FM Radio mode.



Tape Operation

Repeat Play

Set to see a recording over and over.

1  **Display MAIN MENU.**
Press MENU.

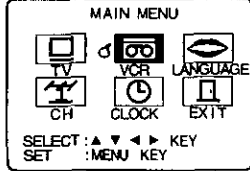
2  **Display SET UP VCR screen.**
1) Press ▲▼◀▶ to select "VCR."
2) Press MENU to display.

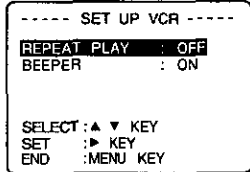
3  **Select REPEAT PLAY.**
1) Press ▲▼ to select.
2) Press ▶ to set "ON" or "OFF."

Notes

- Playback repeats when tape end is reached or unrecorded portion over 30 seconds is detected.
- During playback, you may also press PLAY/REPEAT repeatedly on the Combination VCR until the REPEAT indicator lights up (ON) or goes out (OFF.)

4  **End setup.**
Press MENU twice.

Zero Search

To quickly return to a specific tape counter location.

a  **Display the Counter.**
Press DISPLAY during playback.

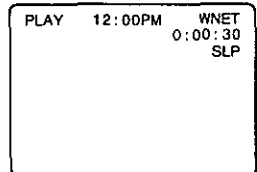
b  **Reset to "0:00:00."**
Press COUNTER RESET at the desired position.

<For Model PV-M2759 only>

c **Continue playback, rewind, or fast forward.**

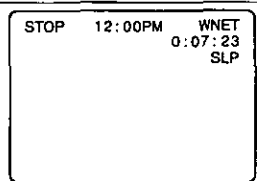
d  **Return to "0:00:00."**
Press ZERO/1 MIN in Stop mode.
• The Combination VCR will go into FF or REW mode and stop at the last point the Counter was set to 0:00:00.

<For Model PV-M2759 only>

Your Combination VCR is equipped with several time saving features as well as convenient automatic functions which make tape operation easier than ever.

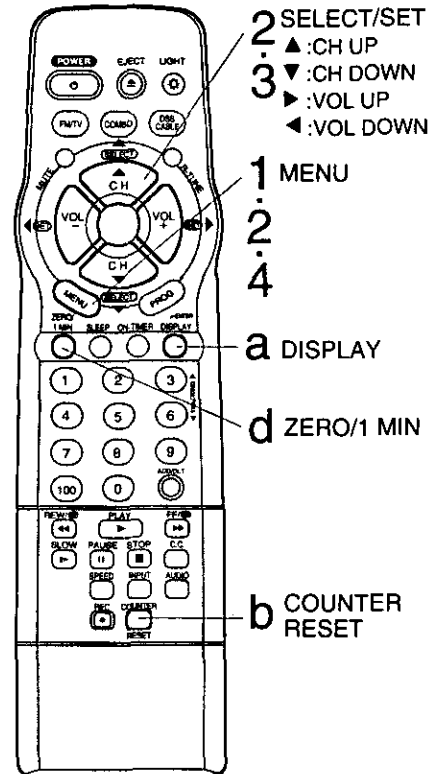

One Minute Skip

Combination VCR fast forwards over 60 seconds of recorded tape.

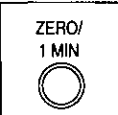
 **Skip over 1 minute.**
Press ZERO/1 MIN in Play mode.

Auto Operation Functions

- **Auto Shut Off**
No broadcast signal in TV or Playback mode for 5 minutes → Turn Power off automatically
• This feature is deactivated if any button is pressed during the above mode.
- **Auto Playback**
Insert a tape in Power off mode → Turn Power on automatically
• Playback begins automatically if a tape has no record tab.
- **Auto Rewind**
A tape reaches its end → Rewind begins → Stop automatically
- **Playback Auto Eject (Repeat Play is "OFF")**
A tape has no record tab reaches its end → Rewind begins → Eject automatically
- **Memory Rewind off**
Press POWER in REW mode → Rewind is completed → Turn Power off automatically

Special VCR Features

* Important: If the remote control POWER, CH Up/Down, MENU, PROG. DISPLAY, ON-TIMER, R-TUNE, FM/TV, or ADD/HLT button does not work when pressed, press COMBO button on the remote and try the button again.

Warning Beeper Feature

When you select BEEPER ON, a short warning will sound each time an invalid entry or incomplete is made.

1



Display MAIN MENU.
Press MENU*.

2

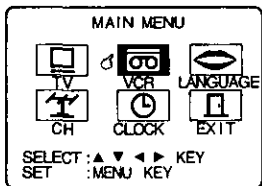

Display SET UP VCR screen.

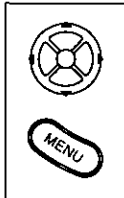

- 1) Press ▲▼◀▶ to select "VCR."
- 2) Press MENU to display.

3

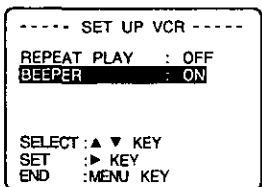

Select BEEPER.

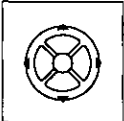

- 1) Press ▲▼ to select.
- 2) Press ▶ to set "ON" or "OFF."

4



Return to normal screen.
Press MENU twice.

Model PV-M2789 unit is shown here.

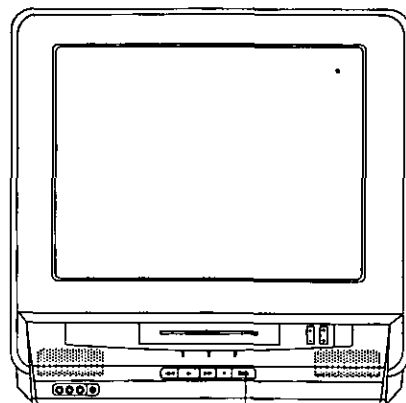

STOP/EJECT

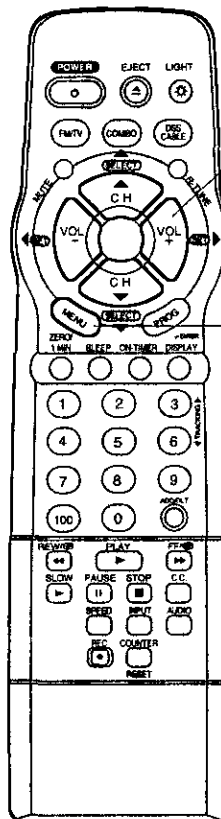

- 2 SELECT/SET
- 3 ▲:CH UP
▼:CH DOWN
▶:VOL UP
◀:VOL DOWN
- 1 MENU
- 2:4

VCR Lock

All operations are prohibited except Timer recording and tape eject. Useful for families with small children.

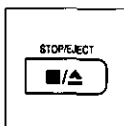
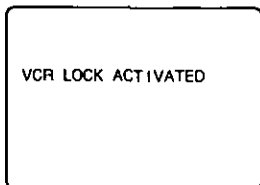

To turn "ON."
In Stop or Power OFF mode, hold down STOP/EJECT on the Combination VCR for 7 seconds.

To turn "OFF."
Repeat this to exit.

- VCR Lock is cancelled automatically after 24 hours if clock is set.

Note

The on screen message will only be displayed on your TV screen if the VCR Lock feature is activated in the Power ON mode.

Advanced Operation

Cable Box Universal Remote Control Feature

The Universal Remote Control Setup

1 Find your DSS box or Cable box Brand Code Number from one of the charts at the bottom of this page.

2

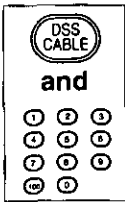

Setup remote.

- 1) Hold down DSS CABLE.
 - 2) Press NUMBERED keys to enter code.
- For code 100 or greater, first press the 100 key first, and then remaining digit. e.g., for 102, press 100, then press 0, and then press 2.

3



Confirm code entry.

Press POWER* to turn selected unit ON or OFF.

- See below for a list of controllable functions in each mode.

Notes

- Please repeat the Universal Remote Control Setup after replacing remote control batteries.
- The remote control will not operate all DSS receivers or Cable Boxes made by these manufactures listed. If you get no results, your particular brand cannot be controlled.

Using the Universal Remote Control

Once the remote control has been properly setup, you can select COMBO, DSS or CABLE mode depending on which functions you wish to control. (See below.)

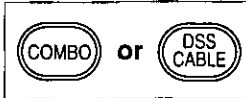

Press COMBO or DSS CABLE on the remote control to select the desired mode. (The below list shows which buttons are available for each mode.)

Set to COMBO:

- All TV and VCR functions

Set to DSS CABLE:

- Basic VCR functions, e.g. PLAY, REC, etc.

Universal Remote Control is...

The Remote Control maybe set up to control some of the functions.

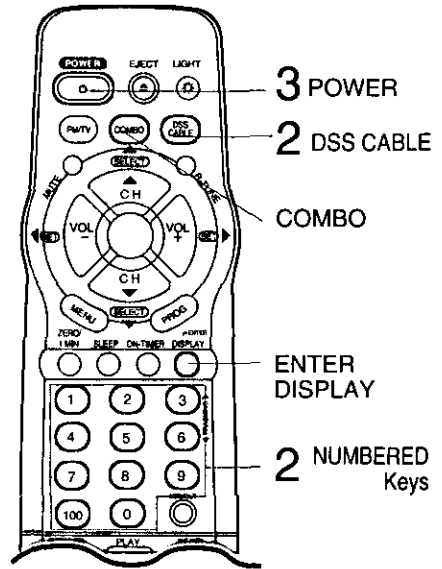

Notes

- In DSS or CABLE mode, it may be necessary to press ENTER after pressing NUMBERED keys for channel selection.
- In DSS or CABLE mode, POWER, CH Up/Down, NUMBERED Keys, MENU, PROG, DISPLAY, ON-TIMER, R-TUNE, FM/TV, and ADD/HLT are not available. Press COMBO to use these functions.
- Depending on your DSS receiver or Cable box brand, some of the functions listed may not be remote controllable.
- Some DSS receiver or Cable box brands require you to turn on the power manually.
- Due to changes in infra-red commands used by manufacturers, some brands have several codes. If your unit does not respond to the first code, please try the next one.

DSS Brand Code Numbers

Toshiba	92	Magnavox/ Uniden 2	95	Sony	98, 105
Hitachi/Hughes	93	Panasonic	96		
Magnavox/ Uniden 1	94	RCA	97		

Cable Box Brand Code Numbers

Archer	01, 05, 06, 44, 63, 91, 126	Matsushita	16, 17, 97, 109	Sheritech	27
Cabletenna	01, 44, 63, 91, 126	Movietime	32, 38, 39, 40, 42, 44, 126	Signal	26, 112
Cableview	04, 30, 42, 44, 52, 63, 124, 126	NEC	32, 38, 40	SL Marx	06, 32, 40, 42, 43, 44, 52, 63, 126
Century	44, 51, 59, 75	NOVAVISION	08, 09, 53, 61	Sprucer	16, 17, 97, 109
Citizlin	04, 30, 42, 44, 52, 63, 124, 126	NSC	32, 38, 40	Standard Components	32, 39, 42, 44, 126
Curtis	08, 09, 53, 61, 87	Oak	11, 46, 129	Stargate	04, 06, 30, 32, 40, 42, 44, 52, 63, 124, 126
Diamond	01, 44, 63, 91, 126	Oak Sigma	11, 46, 129	Sylvania	19
Drake	67	Panasonic	16, 17, 97, 109	Teknika	74
Eagle	13, 20, 22, 26, 40, 58, 62, 107	Philips	07, 13, 20, 23, 24, 50, 128, 129	Telecaption	77, 127
Eastern	28, 130	Pioneer	05, 06	Television	06, 32, 40, 42
GC Brand	04, 30, 42, 44, 52, 63, 124, 126	Pulsar	04, 30, 42, 44, 52, 63, 124, 126	Texscan	18, 19
Gemini	04, 124	Quest	05, 06	Tocom	01, 33, 34, 42, 66, 91
General Electric	01, 57	Radio Shack	44, 51, 59, 75	Toshiba	36
General Instruments	01, 02, 03, 04, 34, 55, 65, 67, 68, 83, 91, 115, 117, 118, 124	RCA	16, 17, 97, 109	Uniden Satellite	65
Hamlin	14, 15, 28, 41, 102, 103, 104, 108, 130	Realistic	44, 51, 59, 75, 126	Unika	01, 44, 63, 91, 126
Hitachi	31	Recoton	44, 51, 59, 75, 126	Universal	42, 43, 44, 52, 63, 126
Jasco	04, 124	Regal	14, 15, 28, 41, 102, 103, 104, 108, 130	Videoway	07, 23, 50, 129
Jerrold	01, 02, 03, 04, 34, 55, 65, 67, 68, 83, 91, 115, 117, 118, 124	Regency	28, 130	Vid Tech	64
Macom	31	Rembran	01, 32, 39, 42, 44, 63, 126	Vidter	64
Magnavox	26, 112	Salora	68	Viewstar	13, 20, 22, 26, 40, 58, 62, 107
		Samsung	05, 06, 32, 40, 42	Zenith	07, 23, 50, 129
		Scientific Atlanta	08, 09, 53, 61, 87		

Adjustment Features

* Important: If the remote control POWER, CH Up/Down, MENU, PROG. DISPLAY, ON-TIMER, R-TUNE, FM/TV, or ADD/DEL button does not work when pressed, press COMBO button on the remote and try the button again.

Picture Adjustment



Display MAIN MENU.
Press MENU.

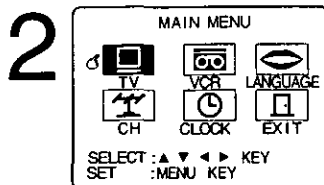

Display SET UP TV screen.

- 1) Press ▲▼◀▶ to select "TV."
- 2) Press MENU to display.

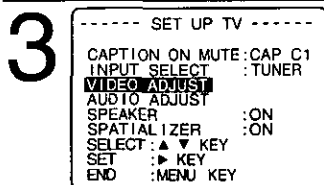
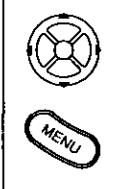

Display VIDEO ADJUST screen.

- 1) Press ▲▼ to select.
- 2) Press ▶ to display.



<For Model PV-M2789 only>

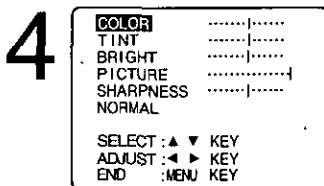

Adjust desired item.

- 1) Press ▲▼ to select an item.
(See below right.)
- 2) Press ◀▶ to adjust.

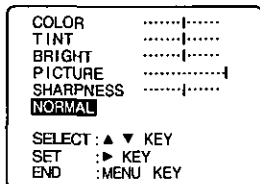
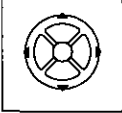

To Reset Picture Controls

Press ▲▼ and ▶ to select and set "NORMAL."
All controls return to their factory settings.

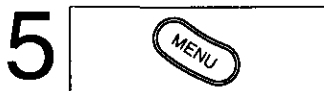

End setup.

Press MENU three times to exit.

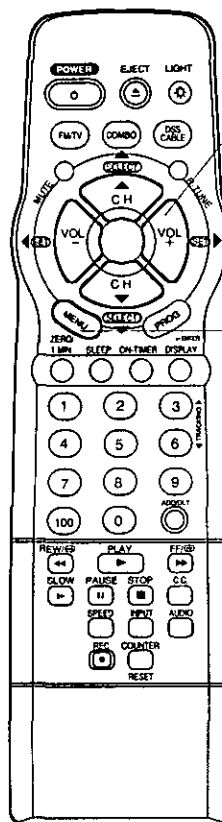

- 2 SELECT/SET
3 ▲:CH UP
4 ▼:CH DOWN
5 ▶:VOL UP
6 ◀:VOL DOWN
1 MENU
2
5

Picture Adjustment

COLOR Control

Adjust color intensity.

TINT Control

Adjust for natural flesh tones.

BRIGHT Control

Adjust picture brightness.

PICTURE Control

Adjust picture intensity by adjusting both contrast and color level in the proper balance.

SHARPNESS Control

Adjust picture sharpness.

Audio Adjustment

BASS Control

To adjust the intensity of low frequency sound.

TREBLE Control

To adjust the intensity of high frequency sound.

- The levels set here do not affect other audio equipment when connected to the Audio Output L/R Connector.

Audio Adjustment <For model PV-M2789 only>

a Do steps 1 and 2 above.

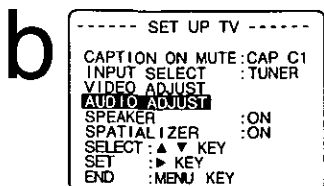

Select AUDIO ADJUST.

- 1) Press ▲▼ to select.
- 2) Press ▶ to set.



<For Model PV-M2789 only>

c Do steps 4 and 5 above.
(See description right.)

Select Audio Mode for Playback

Select the type of sound track you desire for playback.

1

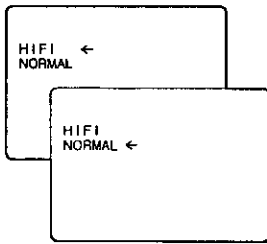

<For Model PV-M2789 only>

Select desired mode.



Press **AUDIO** repeatedly (each press within 5 seconds.)

- Please select HIFI to listen to your stereo recordings with stereo sound or NORMAL for monaural sound.

- This screen appears when you press AUDIO during playback.

2 Playback the tape.

See the "Playback a Tape" section on page 10.

Select Audio Mode for Recording

Select the type of broadcast and sound track you wish to record.

a



Press **AUDIO** to select the desired audio mode. (See page 9.)

- Your recording is always performed according to the audio mode you selected.

b

Do a recording.

See the "Record On a Tape" section on page 11.

With the proper audio mode setting, your Combination VCR can:

- record and playback an MTS stereo broadcast (main language) in stereo Hi-Fi. Stereo sound is recorded on the left and right audio tracks and on the video portion of a tape.
- record and playback a monaural broadcast (main language) or an SAP (Sound Audio Program, usually in a second language) on the Hi-Fi tracks for better quality monaural sound.
- playback non-Hi-Fi tapes in monaural.

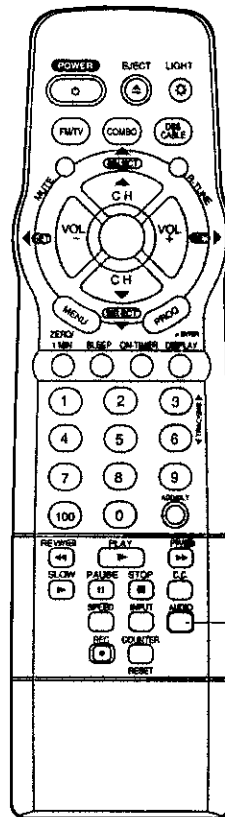

1
a

Notes

- When purchasing or renting prerecorded tapes, remember that only those recorded in Hi-Fi stereo will playback with true stereo sound. Standard stereo tapes will playback with monaural sound.
- In order to listen to Hi-Fi stereo playback, the Combination VCR AUDIO (L/R) jacks must be connected to a stereo amp and speakers.
- There may be a difference in audio level between Hi-Fi and normal audio playback.

Equipped with **dbx**®-TV Noise Reduction for true MTS reproduction.

dbx®-TV Noise Reduction is required for good stereo separation and audio fidelity. **dbx**® is a registered trademark, and is licensed by **dbx**® Technology Licensing.

* Important: If the remote control POWER, CH Up/Down, NUMBER, PROG, DISPLAY, ON-TIMER, R-TUNE, FM/TV, or ADD/DLT button does not work when pressed, press COMBO button on the remote and try the button again.

Speaker ON/OFF System

Allows you to turn off the speaker of the Combination VCR when it is connected to external audio equipment.

1  **Display MAIN MENU.**
Press MENU*.

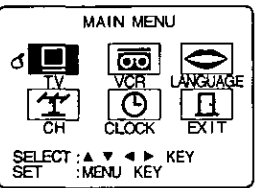
2  **Display SET UP TV screen.**
1) Press ▲▼◀▶ to select "TV."
2) Press MENU to display.

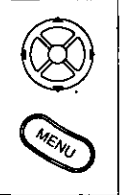

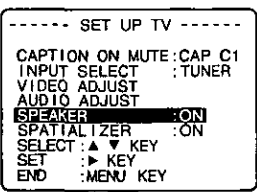
3  **Select SPEAKER.**
1) Press ▲▼ to select.
2) Press ▶ to set "ON" or "OFF."

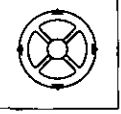

<For Model PV-M2789 only>

4  **End setup.**
Press MENU twice.
• In SPEAKER OFF condition, the MUTE button and VOL + - do not function.

Spatializer Feature

This feature allows you to enhance the stereo sound so that it seems to completely surround you.

NOTE: For playback, tapes must be recorded in Hi-Fi stereo. For TV viewing, programs must be broadcast in stereo.

a Do steps 1 and 2 above.

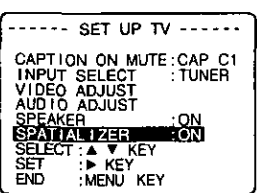
b  **Select SPATIALIZER.**
1) Press ▲▼ to select.
2) Press ▶ to set "ON" or "OFF."



<For Model PV-M2789 only>

c  **End setup.**
Press MENU twice.

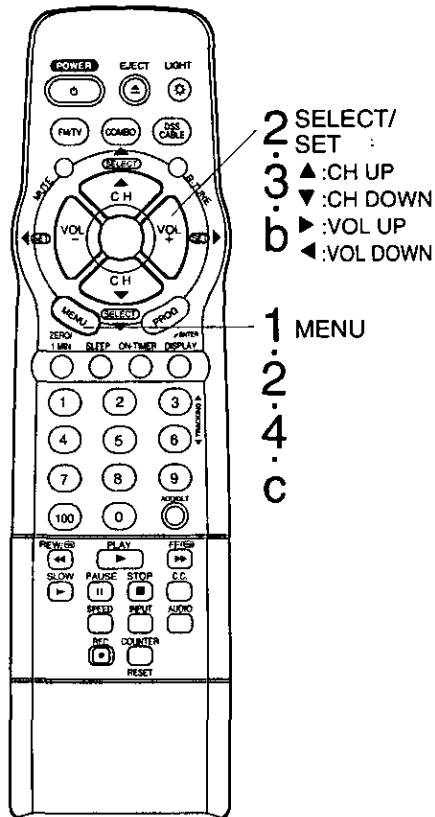

Advanced Operation

Note

Portions of this product manufactured under a license from Desper Products, Inc. SPATIALIZER, and the circle-in-square device are trademarks owned by Desper Products, Inc.

On-Screen Displays (OSD)

VCR Status & Clock Display



To display or remove the overlay.
Press DISPLAY*.

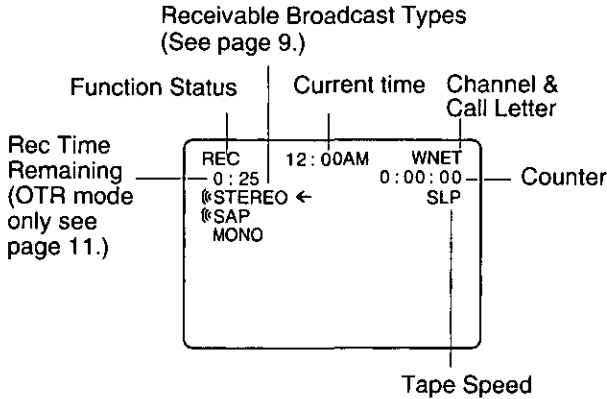

Channel & Function Display

When a function button is pressed (PLAY, FF, etc.) or you change channels, the Combination VCR mode or channel number will be displayed.
(Some station names may also appear.)

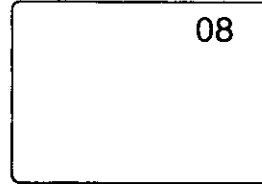

Blue Screen Display

Whenever a blank section of a tape comes up in Play mode, or when the selected channel has no broadcast signal, the TV screen will turn solid blue.

Warning and Instruction Displays

These displays will alert you of a missed operation or provide further instructions.

OSD	Caution	Pg	OSD	Caution	Pg
NO CH FOUND PLEASE CHECK ANTENNA CABLE CONNECTION THEN PUSH CH UP KEY AGAIN	If no active channels are found for CHANNEL MEMORY...	5	NO CASSETTE PLEASE INSERT A CASSETTE	If you press PLAY, FF, REW, or REC on the remote control or the Combination VCR without a cassette inserted...	10 11
PLEASE SET CLOCK BEFORE PROGRAMMING	If you attempt to set or review a Timer Recording or set the On-Timer and the Clock is not set...	6 7	PLEASE PREPARE FOR TIMER REC	If the Combination VCR is not in Stop mode or a cassette with record tab is not inserted two minutes before a Timer Recording is about to begin...	12 13
CHECK CASSETTE RECORD TAB	If you press REC on the remote control or the Combination VCR, and a cassette is inserted with no record tab...	4 11	VIDEO HEADS MAY NEED CLEANING PLEASE INSERT HEAD CLEANING CASSETTE OR REFER TO MANUAL END: PLAY KEY	If head cleaning becomes necessary while playing back a tape...	29
TO CANCEL TIMER REC HOLD DOWN STOP KEY FOR APPROX 3 SEC	If you press STOP during a Timer Recording...	13	VCR LOCK ACTIVATED	If you press a function button other than STOP/EJECT or POWER while the Combination VCR is in VCR Lock mode...	23

Unit Information

*Important: If the remote control POWER, CH Up/Down, MENU, PROG, DISPLAY, ON-TIMER, R-TUNE, FM/TV, or ADD/HLT button does not work when pressed, press COMBO button on the remote and try the button again.

Reset all Combination VCR Memory Functions

Use when moving Combination VCR to new location, or if a mistake was made in the One Time Setup section.

- Make sure a tape is not inserted in the Combination VCR.

Model PV-M2789 unit is shown here.

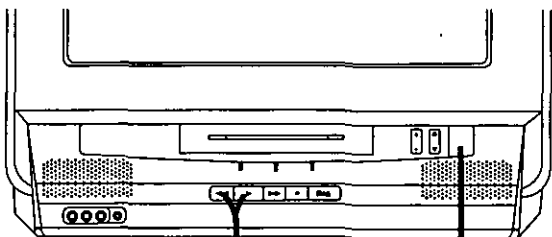

1 Turn the Combination VCR Power on.

2 Press and hold both the REWIND and PLAY on the Combination VCR for more than 5 seconds.

- The power will shut off.

3 Do "One Time Setup" Steps on page 6.

DST (Daylight Saving Time)

Combination VCR auto adjusts clock for DST (Daylight Saving Time.)

Spring (First Sunday in April)

DST:ON → Sets clock ahead one hour.

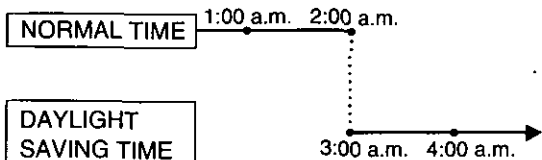

Autumn (Last Sunday in October)

DST:ON → Turns clock back one hour.

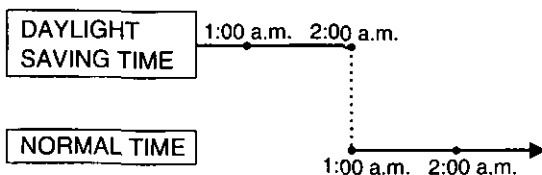

- If your area does not observe Daylight Saving Time, select DST: OFF.
- Keep these time changes in mind when programming the Combination VCR for timer recordings.

Head Cleaning

Playing older or damaged tapes may eventually cause video heads to become clogged.

Head Clog Sensor

During playback this screen appears if clogging is detected. To remove screen, press PLAY on the remote or Combination VCR.

- Use "dry" type head cleaning cassette only. (Part No. NV-TCL30PT is recommended.)

- Follow cleaning tape carefully. Excessive use of tape can shorten head life.

- If head clog symptoms persist, contact your nearest Factory Service Center or authorized Service Center. (See page 31.)

VIDEO HEADS MAY NEED CLEANING PLEASE INSERT HEAD CLEANING CASSETTE OR REFER TO MANUAL

END:PLAY KEY

Specifications

Display

Picture Tube: 27 inch measured diagonal 100° deflection Picture Tube

VCR

Video Recording System: 2 rotary heads helical scanning system (PV-M2759)
4 rotary heads helical scanning system (PV-M2789)
Audio Track: 1 track (NORMAL)
2 channel (Hi-Fi Audio Sound) (PV-M2789)

Tuner:

Broadcast Channels: VHF 2-13, UHF 14-69
CATV Channels: Midband A through I (14-22)
Superband J through W (23-36)
Hyperband AA-EEE (37-64)
Lowband A-5-A-1 (95-99)
Special CATV channel 5A (01)
Ultraband 65-94, 100-125

FM Radio

Band range: 87.5-108.1 MHz

General

Power Source: 120V AC, 60 Hz
Power Consumption: Approx. 157 watts (Power on)
Approx. 7 watts (Power off)
Television System: EIA Standard NTSC color
Speaker: 2 pieces
Operating Temperature: 41°F~104°F (5°C~40°C)
Operating Humidity: 10%-75%
Weight: 86 lbs. (39 Kg)
Dimensions: 27-1/16" (W) X 27-15/16" (H)
X21-5/16" (D)
688 (W) X 659 (H) X 542 (D)
mm

Note: Designs and specifications are subject to change without notice.

Before Requesting Service

Check the following points once again if you are having trouble with your Combination VCR.

Power	Correction
No power...	<ul style="list-style-type: none"> • Completely insert Power Plug into an AC outlet. • Set POWER button to ON.
Monitor	Correction
No picture or sound...	<ul style="list-style-type: none"> • Make sure your antenna system (TV or CATV), is correctly set. (P. 5) • Check that power plug is completely plugged into an AC outlet. • Check that POWER button is set to on.
Poor picture with normal sound...	<ul style="list-style-type: none"> • Adjust BRIGHT, SHARPNESS, and PICTURE controls in the SET UP TV menu. (P.25)
Poor sound with normal picture...	<ul style="list-style-type: none"> • Adjust VOLUME control. (P.8)
Poor TV reception...	<ul style="list-style-type: none"> • Adjust SHARPNESS and PICTURE controls in the SET UP TV menu. (P.25)
No color or poor color...	<ul style="list-style-type: none"> • Adjust TINT and COLOR controls in the SET UP TV menu. (P.25)
Ghost (multiple) images...	<ul style="list-style-type: none"> • Install a directional antenna.
TV programs cannot be watched...	<ul style="list-style-type: none"> • Make sure that the channel being received is in the Combination VCR's memory. (P. 7)
Channel cannot be selected...	<ul style="list-style-type: none"> • The design of this unit is such that only the channel being recorded can be viewed.
VCR	Correction
TV program cannot be recorded...	<ul style="list-style-type: none"> • Make sure your antenna system (TV or CATV), is correctly set. (P. 5) • Make sure cassette record tab is intact. (P. 4)
Timer recording cannot be performed...	<ul style="list-style-type: none"> • Check clock is set to current time and date. • Make sure DSS/CABLE box (if used) is left on and tuned to channel to be recorded. • Set recording Start/Stop time correctly. (P.12-13) • Timer recording may not be performed or continued if a power interruption of more than 1 minute occurs before or during a Timer Recording, after power is restored.
No playback picture, or the playback picture is noisy or contains streaks...	<ul style="list-style-type: none"> • Adjust TRACKING control in either direction. (P.10) • Try Head Cleaning. (P.29)
VCR cannot be controlled...	<ul style="list-style-type: none"> • Make sure VCR LOCK is set to off. (P. 23)
Remote Control	Correction
Combination VCR cannot be controlled...	<ul style="list-style-type: none"> • Aim Remote directly at the remote sensor on the Combination VCR. (P. 37) • Avoid any object blocking signal path. • Inspect the remote batteries. (P. 4) • Make sure VCR LOCK is set to off. (P. 23) • Exposing Combination VCR remote sensor to direct fluorescent or outdoor light may cause signal interference.
MENU , PROG, ON-TIMER and FM/TV buttons cannot be used...	<ul style="list-style-type: none"> • Press COMBO button for COMBO mode. (P. 24) • Check Batteries.
Miscellaneous	Correction
Video cassette cannot be inserted...	<ul style="list-style-type: none"> • Insert the cassette window side up; record tab facing you.
Video cassette cannot be removed...	<ul style="list-style-type: none"> • Completely insert Power Plug into an AC outlet.
Eject does not function or insertion cannot be done...	<ul style="list-style-type: none"> • Turn the POWER off and then on, and try ejecting or inserting the tape again.
Video cassette ejects when a recording is started, or the power is turned off for timer recording...	<ul style="list-style-type: none"> • Make sure cassette record tab is intact. (P. 4)
In stop mode, the VCR motor (CYLINDER) continues to rotate...	<ul style="list-style-type: none"> • To enable Quick Play mechanism, the VCR cylinder will rotate for about 5 minutes. This reduces response time from Stop to Play mode and from Play to Rewind Search mode.
VCR cannot be controlled...	<ul style="list-style-type: none"> • Make sure VCR LOCK is set to off. (P. 23)

If you cannot resolve the problem, please call the Customer Satisfaction Center for product assistance at 201-348-9090.

To locate an authorized servicenter call toll free 1-800-211-PANA(7262.)

Service Center List

For Product Information, Operating Assistance, Literature Request, Dealer Locations, and all Customer Service inquiries please contact:
1-800-211-PANA (7262), Monday-Friday 9 am-9 pm Saturday-Sunday 9 am-7 pm, EST.

Web Site: <http://www.panasonic.com>
You can purchase parts, accessories or locate your nearest servicer by visiting our Web Site.

Accessory Purchases:

1-800-332-5368 (Customer Orders Only)
Panasonic Services Company 20421 84th Avenue South, Kent, WA 98032
(6 am to 5 pm Monday-Friday; 6 am to 10:30 am Saturday; PST)
(Visa, MasterCard, Discover Card, American Express, Check)

Factory Servicenters Locations

CALIFORNIA

6550 Katella Avenue
Cypress, CA 90630

800 Dubuque Avenue
S. San Francisco,
CA 94080

20201 Sherman Way
Suite 102
Canoga Park, CA
91306

3878 Ruffin Road
Suite A
San Diego, CA 92123

COLORADO

1640 South Abilene
Street
Suite D
Aurora, CO 80012

FLORIDA

3700 North 29th Avenue
Suite 102
Hollywood, FL 33020

GEORGIA

8655 Roswell Road
Suite 100
Atlanta, GA 30350

ILLINOIS

9060 Golf Road
Niles, IL 60714

1703 North Randall
Road Elgin, IL 60123
(Pick-up/Drop-off only)

MARYLAND

62 Mountain Road
Glen Burnie, MD 21061

MASSACHUSETTS

60 Glacier Drive,
Suite G
Westwood, MA 02090

MICHIGAN

37048 Van Dyke
Avenue
Sterling Heights,
MI 48312

MINNESOTA

7850-12th Avenue South
Airport Business Center
Bloomington, MN 55425

OHIO

2236 Waycross Road
Civic Center Plaza
Forest Park, OH 45240

PENNSYLVANIA

2221 Cabot Blvd West
Suite B
Langhorne, PA 19047

Chartiers Valley
Shopping Center
1025 Washington Pike
Bridgeville, PA 15017

TENNESSEE

3800 Ezell Road Suite
806
Nashville, TN 37211

TEXAS

7482 Harwin Drive
Houston, TX 77036

13615 Welch Road
Suite 101
Farmers Branch,
TX 75244

WASHINGTON

20425-84th Avenue
South Kent, WA 98032

HAWAII

99-859 Iwaiwa Street
Aiea, Hawaii 96701
Phone (808) 488-1996
Fax (808) 486-4369

Service in Puerto Rico

Matsushita Electric of Puerto Rico, Inc. Panasonic Sales Company/Factory Servicer:
Ave. 65 de Infanteria, Km. 9.5, San Gabriel Industrial Park, Carolina, Puerto Rico 00985
Phone (787) 750-4300 Fax (787) 768-2910

For Your Information

As of April '98

Conexión de la antena externa

Desenganche la antena del televisor o de la videograbadora que tuviera anteriormente y conéctela a la parte trasera del registrador Combinación de VCR/TV, como se muestra en el diagrama. Si el sistema de su antena tiene conductores UHF y VHF separados, usted necesita un mezclador de banda UHF/VHF (no viene con el equipo.)

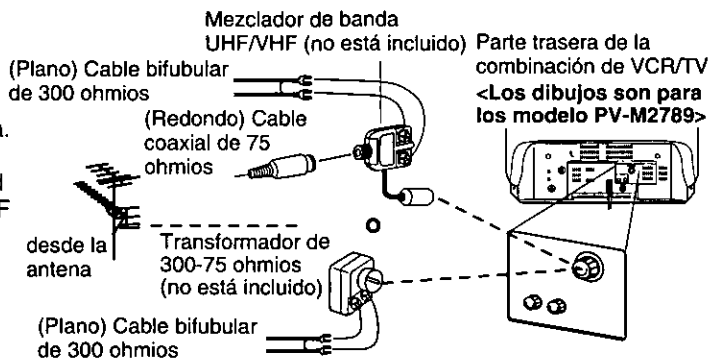

Conexiones de TV cable

■ Sin un decodificador de TV cable

- Podrá;
- grabar o ver canales sin codificar.
- No Podrá;
- grabar o ver canales codificados.
 - ver otro canal que no sea el seleccionado para cualquier tipo de grabación.

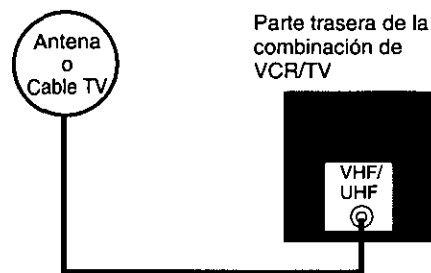

■ Con un decodificador de TV cable

- Podrá;
- grabar o ver cualquier canal incluso los canales codificados.
- NOTA:
El canal deberá ser seleccionado en el decodificador de TV cable.
- No Podrá;
- ver otro canal que no sea el seleccionado para cualquier tipo de grabación.
 - hacer una grabación con temporizador de un canal a menos que lo seleccione en el decodificador de TV cable.

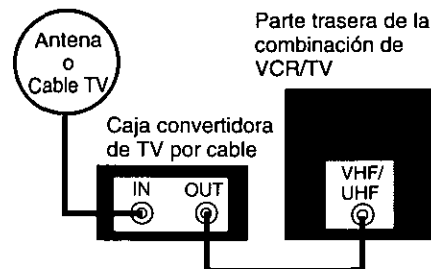

Para ver y grabar un canal codificado/ no codificado

Sintonice el canal del Registrador de la combinación de VCR/TV en el canal de salida de la caja convertidora de televisión por cable (por ejemplo el canal 3.) Después, seleccione en el decodificador de TV cable el canal que se quiera ver o grabar.

■ Con un receptor DSS

- Podrá;
- grabar o ver cualquier canal incluso los canales codificados.
- NOTA:
El canal deberá ser seleccionado en el receptor DSS.
- No Podrá;
- ver otro canal que no sea el seleccionado para cualquier tipo de grabación.
 - hacer una grabación con temporizador de un canal a menos que lo seleccione en el receptor DSS.

NOTA:

El receptor DSS debe estar apagado para ver programas desde un decodificador de TV cable o desde la antena. Consulte el manual del receptor DSS para más detalles.

DSS es una marca registrada de DIRECTTV, INC., una unidad de GM Hughes Electronics.

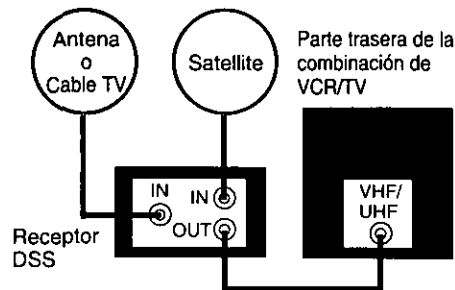

Para fijar el idioma, canal y reloj

1 Presione **POWER** para encender el videograbador combinado.

2 **SELECT LANGUAGE**
 PUSH CH ▲ : English
 OPRIMIR CH ▼ : Español
 APP. VOL + : Français

Seleccione el lenguaje.
 CH ▲ : para inglés
 CH ▼ : para español
 VOL+ : para francés

3 **FIJACION AUTO. (CA/RELOJ)**
 CONECTE EL CABLE DE LA ANTENA Y SI ESTA USANDO UNA CAJA DE TV POR CABLE SINTONICE AL CANAL PBS DE SU LOCAL LUEGO...
 POR FAVOR OPRIMIR CH UP

Comience el ajuste automático de canales y el ajuste automático del reloj.
 Presione CH ▲.

Las siguientes informaciones aparecerán seguidamente:

- AUTOPROGRAMACION EN PROCESO
- AUTOPROGRAMACION COMPLETO
- FIJACION AUTOMATICA DEL RELOJ EN PROCESO

Caso 1

7/28/1999 MAR 12:00PM
 HORA VERANIEGA: ACT
 CANAL FIJADO : CA 10
 FIJACION AUTOMATICA
 COMPLETO
 TERMINAR : OPRIMIR CH UP

(Ajuste terminado)

Presione CH ▲ para salir.

- Si la hora indicada y DST no son correctos, vea la sección "Para fijar o fijar de nuevo el reloj."

Caso 2

FIJACION AUTOMATICA DEL RELOJ ES INCOMPLETO
 PULSE MENU PARA FIJAR EL RELOJ

(Ajuste sin terminar)

Caso 2 El ajuste del reloj es incompleto. Ajuste el reloj manualmente.

A

FIJACION AUTOMATICA DEL RELOJ ES INCOMPLETO
 PULSE MENU PARA FIJAR EL RELOJ

Exhiba la pantalla FIJAR RELOJ.

Presione MENU para salir de este modo.

B

FIJAR RELOJ
 VERANO:ACT
 ELEGIR MES
 ELEGIR: ▲ ▼
 FIJAR : ►
 TERMINAR: ACTION

Ajuste el reloj manualmente.

- 1) Presione ▲▼ para seleccionar el mes.
- 2) Presione ► para ajustar.

- De la misma manera, ajuste el día, el año, la hora y la hora de ahorro de energía. (VERANO)

Para hacer correcciones, presione repetidamente ◀► para moverse hasta el error, luego corríjalo.

C Final del ajuste.

Presione dos veces MENU.

Para fijar o fijar de nuevo el reloj

En caso de que el reloj es incorrecto o ha ocurrido un corte eléctrico.

- 1 Oprima MENU para que parezca el MENU PRINCIPAL.
- 2 Oprima ▲▼◀► para elegir "RELOJ." Luego, oprima MENU para que aparezca la pantalla de la FIJACION RELOJ.
- 3 Oprima ▲▼ para elegir "MANUAL," y luego ► para que aparezca la pantalla de la FIJACION RELOJ.
- 4 Por favor continúe con los pasos B y C de la instrucción anterior (Caso 2.)

NOTA IMPORTANTE PARA AJUSTE AUTOMATICO DEL RELOJ

- El ajuste automático del reloj será realizado al volver a encender el videograbador combinado cada vez que lo apague. Si usa un decodificador de TV cable y desea que la función de ajuste automático del reloj funcione, el decodificador de TV cable debe quedar encendido y sintonizando el canal PBS en el momento en que se apaga el videograbador combinado.
- Si usa un sintonizador de TV satelital, para que funcione el ajuste automático del reloj, debe de estar apagado.
- Si usa un toma de audio/video para conectar el videograbador combinado y el decodificador de TV cable o el sintonizador de TV satelital, deberá también conectar el cable coaxial RF para poder usar las funciones de ajuste automático de reloj y ajuste automático de canal.
- Si por cualquier razón se cambiara la hora manualmente, no se podrá realizar la corrección automática de la hora.

Operaciones básicas para la reproducción

- 1 Inserte un casete.**
 - El videograbador combinado se enciende automáticamente.
- 2 Presione PLAY.**
 - La reproducción comienza automáticamente si el casete no tiene la lengüeta para prevención de grabación.
 - Para encontrar una escena en particular
 - Búsqueda hacia adelante → Presione FF
 - Búsqueda hacia atrás → Presione REW
 - Para ver en cámara lenta → Presione SLOW
 - Para ver una imagen fija (congelada) → Presione PAUSE
 - Para ver imágenes cuadro a cuadro → Presione SLOW en el modo de imagen fija.
 - Para parar → Presione STOP
 - Para rebobinar la cinta → Presione REW
 - Para expulsar la cinta → Presione EJECT en el control remoto o STOP/EJECT en el videograbador combinado.

Operaciones básicas para la grabación

- 1 Inserte un casete con la lengüeta para prevención de grabado.**
 - El videograbador combinado se enciende automáticamente.
- 2 Seleccione el canal.**

Presione CH ▲▼ o las teclas numéricas correspondiente.
- 3 Seleccione la velocidad de grabación.**

Presione SPEED.

SP = reproducción normal
 LP = reproducción larga
 SLP = reproducción super larga

 - La velocidad seleccionada debe aparecer en la pantalla.
- 4 Comience la grabación.**

Presione REC.

 - Para editar partes no deseadas de una grabación, presione PAUSE para hacer una pausa durante la grabación.
 - No podrá ver otro canal durante la grabación.
 - Para parar → Presione STOP.
 - El videograbador combinado deja de grabar a una hora prefijada. (Grabación de un toque)
 - Presione REC repetidamente para ajustar la hora de grabación (30 min - 4 horas.)

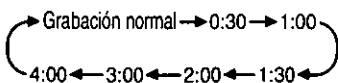

Grabación con temporizador

- 1 Exhiba FIJAR PROGRAMACION.**

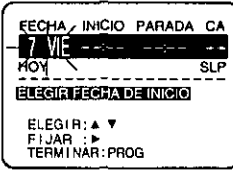
Presione PROG.
- 2 Exhiba TEMPORIZADOR.**

 - 1) Presione ▲▼ para seleccionar.
 - 2) Presione ► para exhibir.
 - Si ya existe un programa en la memoria, presione ▲▼ y ► para seleccionar un número de programa sin usar.
- 3 Ajuste la fecha de grabación.**

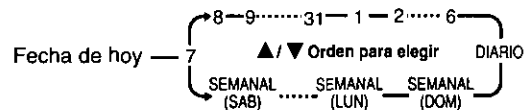
 - 1) Presione ▲▼ para seleccionar.
 - 2) Presione ► o ◀ para ajustar.

- 1 - 31 = Grabación única
- DIARIO = a la misma hora de lunes a viernes
- SEMANAL = a la misma hora una vez a la semana



Repita el paso 3 para ajustar:
 hora de comienzo, hora de parada, canal (o LINEA para una fuente exterior), velocidad (SP, LP, SLP)

- 4 Termine el programa.**

Presione PROG.

Para introducir más programas.

presione ▲▼ y ► para seleccionar y ajustar el número de programa en blanco, y luego repita los paso 3.

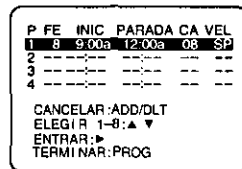

- 5 Salga de este modo.**

Presione PROG dos veces.

 - Si está usando un decodificador de TV cable, asegúrese que se encuentra en el canal deseado y que la alimentación queda conectada para grabar con temporizador.
 - El indicador PROG TIMER se enciende en el videograbador combinado.

Warranty

Panasonic Consumer Electronics Company,
Division of Matsushita Electric Corporation of America,
One Panasonic Way
Secaucus, New Jersey 07094

Panasonic Sales Company,
Division of Matsushita Electric of Puerto Rico, Inc.
AVE. 65 de Infanteria, Km. 9.5 San Gabriel
Industrial Park Carolina, Puerto Rico 00985

Panasonic Video Products Limited Warranty

Panasonic Consumer Electronics Company or Panasonic Sales Company (collectively referred to as "the Warrantor") will repair this product with new or refurbished parts, free of charge, in the USA or Puerto Rico, in the event of a defect in materials or workmanship as follows (all time periods commence from the date of the original purchase):

<u>PRODUCT</u>	<u>PARTS</u>	<u>LABOR</u>
CAMCORDER	ONE (1) YEAR, EXCEPT CCD IMAGE SENSOR CCD IMAGE SENSOR - SIX(6)MONTHS	NINETY (90) DAYS NINETY (90) DAYS
VCR	ONE (1) YEAR	NINETY (90) DAYS
AV MIXER	ONE (1) YEAR	NINETY (90) DAYS
MONITOR-VCR	ONE (1) YEAR, EXCEPT CRT CRT - TWO (2) YEARS	NINETY (90) DAYS CRT - NINETY (90) DAYS CUSTOMER PAYS ALL LABOR CHARGES AFTER 90 DAYS

Monitor-VCR In-home or carry-in Service: 22" (diagonal) CRT / LCD and Larger Monitor-VCR Carry-in Service: 21" (diagonal) CRT / LCD and smaller

Batteries (if included) - New rechargeable batteries in exchange for defective rechargeable batteries for ten (10) days. Non-rechargeable batteries are not warranted.

Tape (if included) - New video cassette tape in exchange for a defective video cassette tape for five (5) days.

In-home, carry-in or mail-in service, as applicable, in the USA can be obtained during the warranty period by contacting a Panasonic Services Company (PASC) Factory Servicenter listed in the Service Directory. Or call toll free 1-800-211-PANA(7262), to locate an authorized PASC Servicenter. Carry-in or mail-in service in Puerto Rico can be obtained during the warranty period by calling the Panasonic Sales Company telephone number listed in the Servicenter Directory.

This warranty is extended only to the original purchaser. A purchase receipt or other proof of the date of the original purchase is required before warranty service is rendered.

This warranty only covers failures due to defects in materials and workmanship which occur during normal use and does not cover normal maintenance, including, but not limited to, video and audio head cleaning. The warranty does not cover damage which occurs in shipment, or failures which are caused by products not supplied by the warrantor, or failures which result from accident, misuse, abuse, neglect, mishandling, misapplication, alteration, modification, faulty installation, set-up adjustments, improper antenna, inadequate signal pickup, maladjustment of consumer controls, improper operation, power line surge, improper voltage supply, lightning damage, commercial use such as hotel, office, restaurant, or other business or rental use of the product, or service by anyone other than a PASC Factory Servicenter or a PASC authorized Servicenter, or damage that is attributable to acts of God.

LIMITS AND EXCLUSIONS

There are no express warranties except as listed above.

THE WARRANTOR SHALL NOT BE LIABLE FOR INCIDENTAL OR CONSEQUENTIAL DAMAGES (INCLUDING, WITHOUT LIMITATION, DAMAGE TO TAPES) RESULTING FROM THE USE OF THIS PRODUCTS, OR ARISING OUT OF ANY BREACH OF THE WARRANTY. ALL EXPRESS AND IMPLIED WARRANTIES, INCLUDING THE WARRANTIES OF MERCHANTABILITY AND FITNESS FOR PARTICULAR PURPOSE, ARE LIMITED TO THE APPLICABLE WARRANTY PERIOD SET FORTH ABOVE.

Some states do not allow the exclusion or limitation of incidental or consequential damages, or limitations on how long an implied warranty lasts, so the above exclusions or limitations may not apply to you.

This warranty gives you specific legal rights and you may also have other rights which vary from state to state.

If a problem with this product develops during or after the warranty period, you may contact your dealer or Servicenter. If the problem is not handled to your satisfaction, then write to the Customer Satisfaction Center at the Panasonic Consumer Electronics Company address above.

SERVICE CALLS WHICH DO NOT INVOLVE DEFECTIVE MATERIALS OR WORKMANSHIP AS DETERMINED BY THE WARRANTOR, IN ITS SOLE DISCRETION, ARE NOT COVERED. COSTS OF SUCH SERVICE CALLS ARE THE RESPONSIBILITY OF THE PURCHASER.

warvid 10/20/97

Location of Controls

Remote Control Buttons

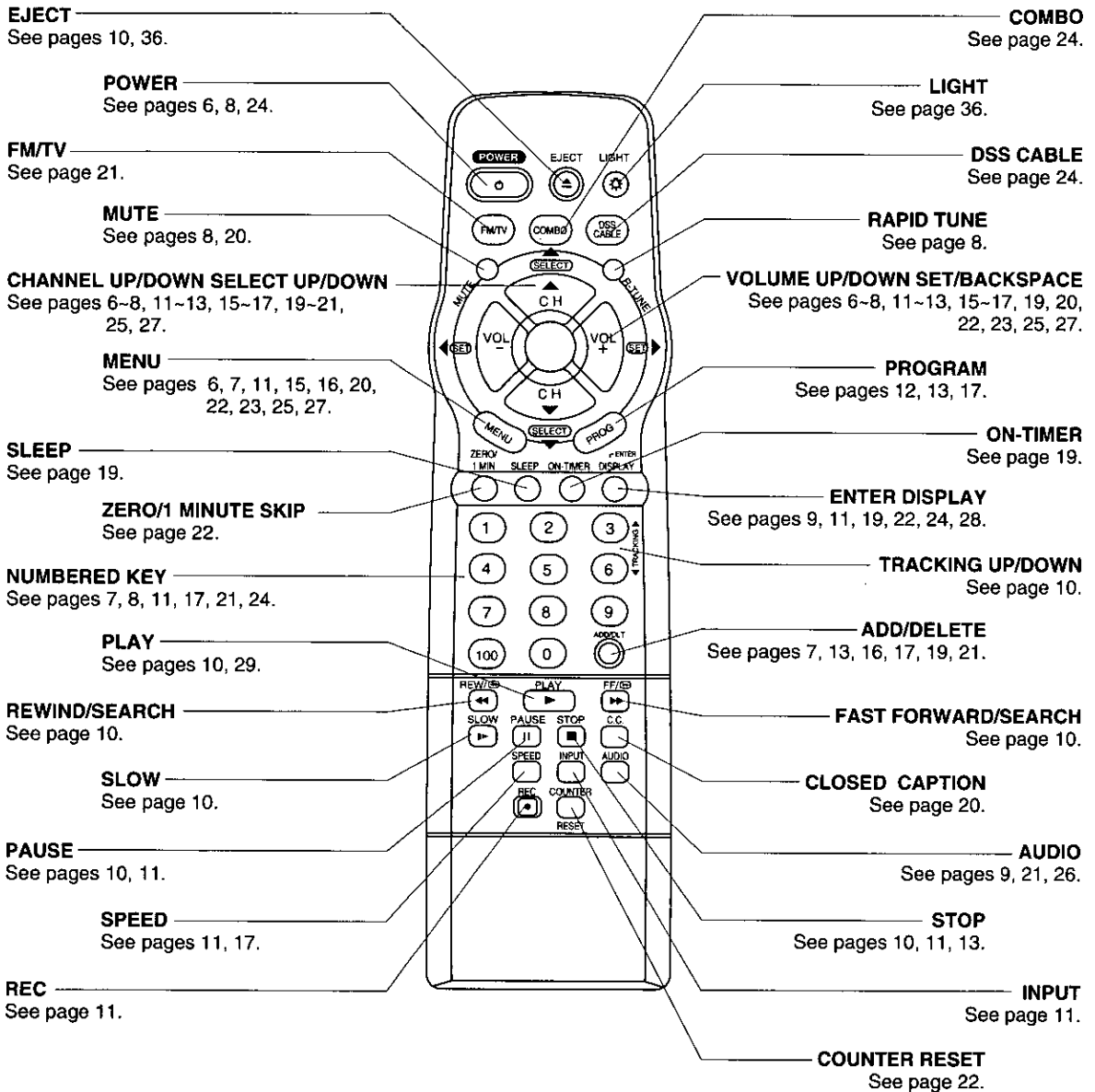

Light Tower™ Universal Remote Control

LIGHT button:

When the LIGHT button is pressed, the buttons which can be activated in the selected mode will light and the selected mode button (COMBO or DSS CABLE) will flash for 5 seconds. If no buttons are pressed within 5 seconds, the light will turn off in order to conserve battery power. Also, while holding down the buttons, the selected mode button will flash so you will be able to see, in the dark, which mode has been selected.

EJECT button:

When EJECT is pressed, the tape is ejected from Cassette Compartment.

If EJECT is pressed during recording, the Combination VCR will not respond to the command.

Front View of the Combination VCR and Indicators on the Front Panel

Model PV-M2789 unit is shown here.

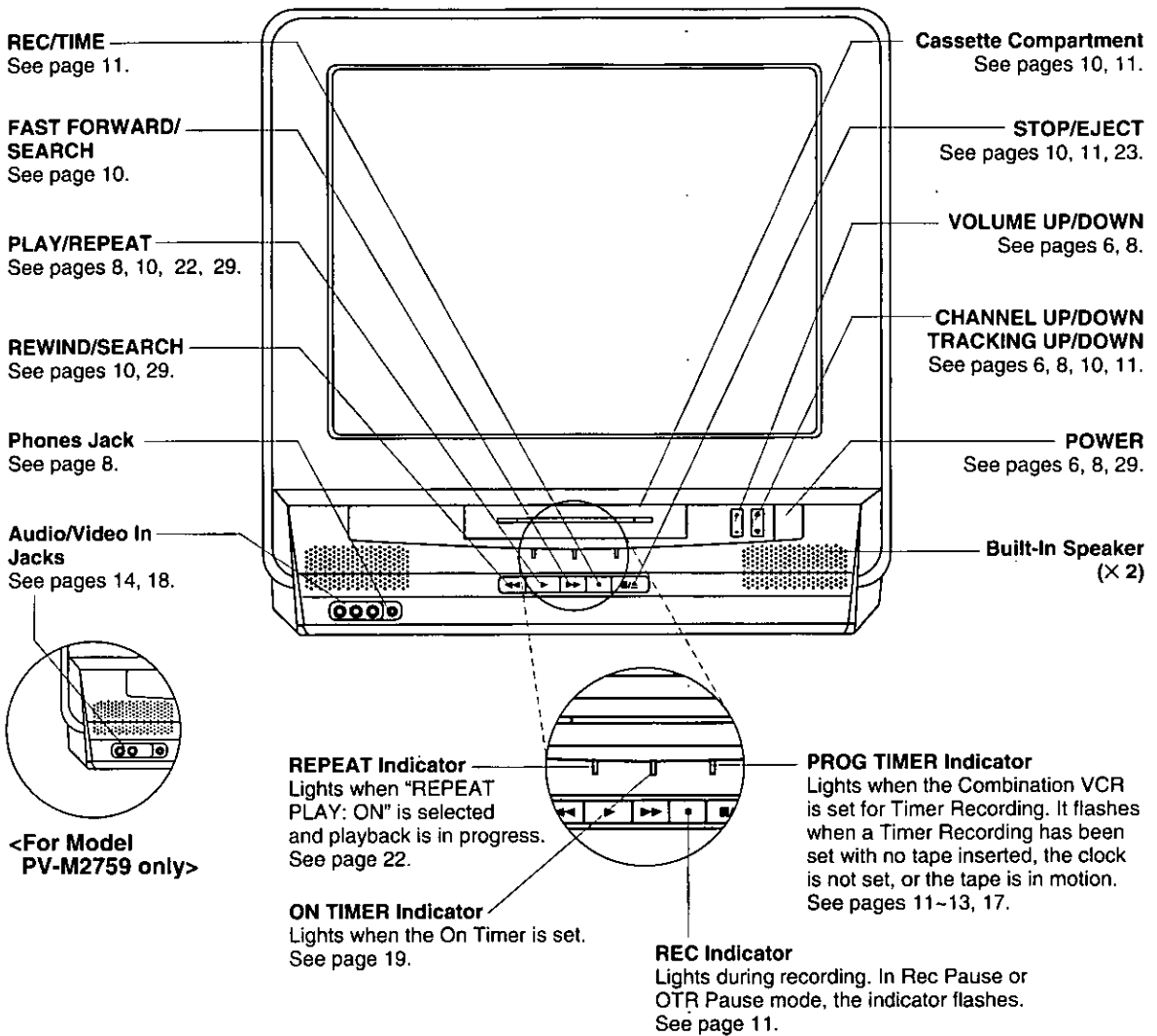

Rear View of the Combination VCR

Model PV-M2789 unit is shown here.

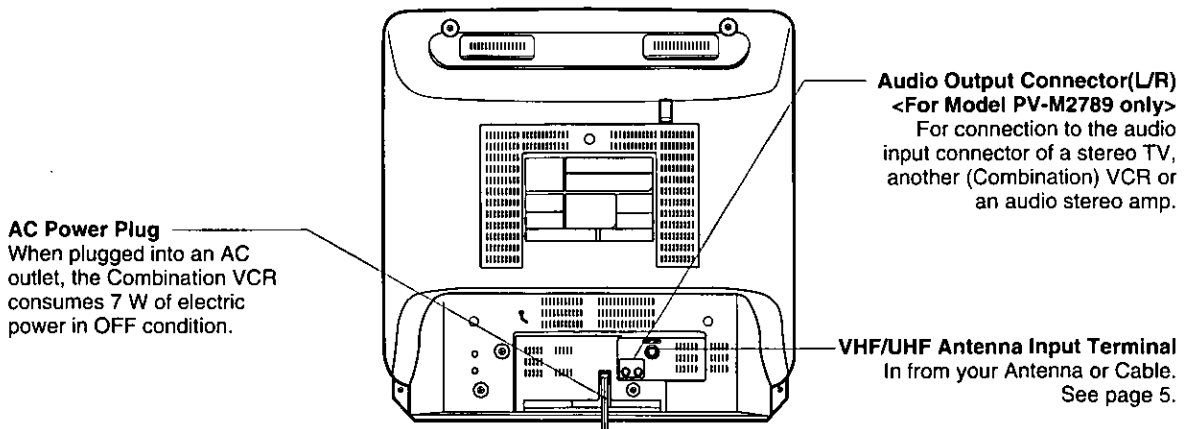

**Panasonic Consumer Electronics Company,
Division of Matsushita Electric Corporation of America**
One Panasonic way Secaucus,
New Jersey 07094

Printed in Japan
VQTS3555A

**Panasonic Sales Company,
Division of Matsushita Electric of
Puerto Rico, Inc. ("PSC")**
Ave. 65 de Infantería. Km. 9.5
San Gabriel Industrial Park, Carolina,
Puerto Rico 00985

